

Cadres d'éventail

Découpez les cadres ci-dessous et utilisez-les pour vos projets ou lapbooks. Utilisez une perforatrice pour faire des trous où se trouvent les petits cercles et assemblez vos cadres avec une agrafe. Utilisez une pochette pour fixer les cadres à votre projet ou lapbook.

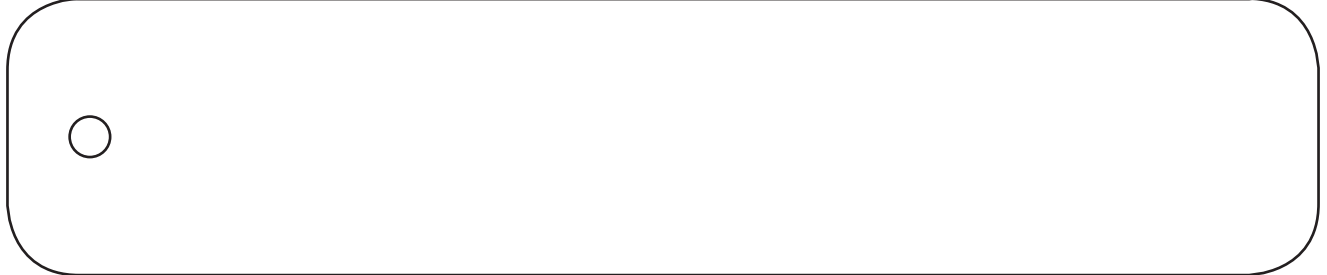

twinkl.com

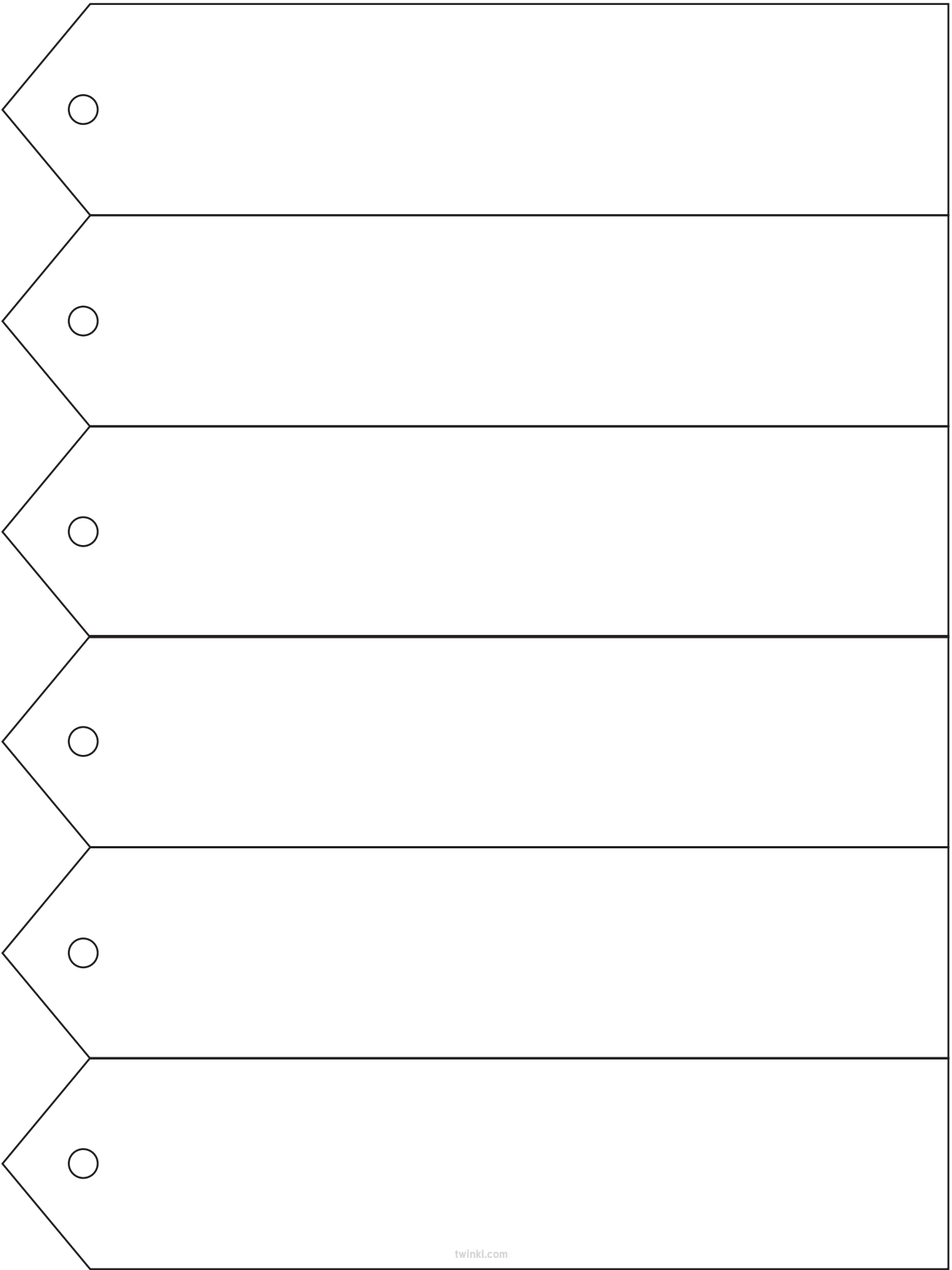

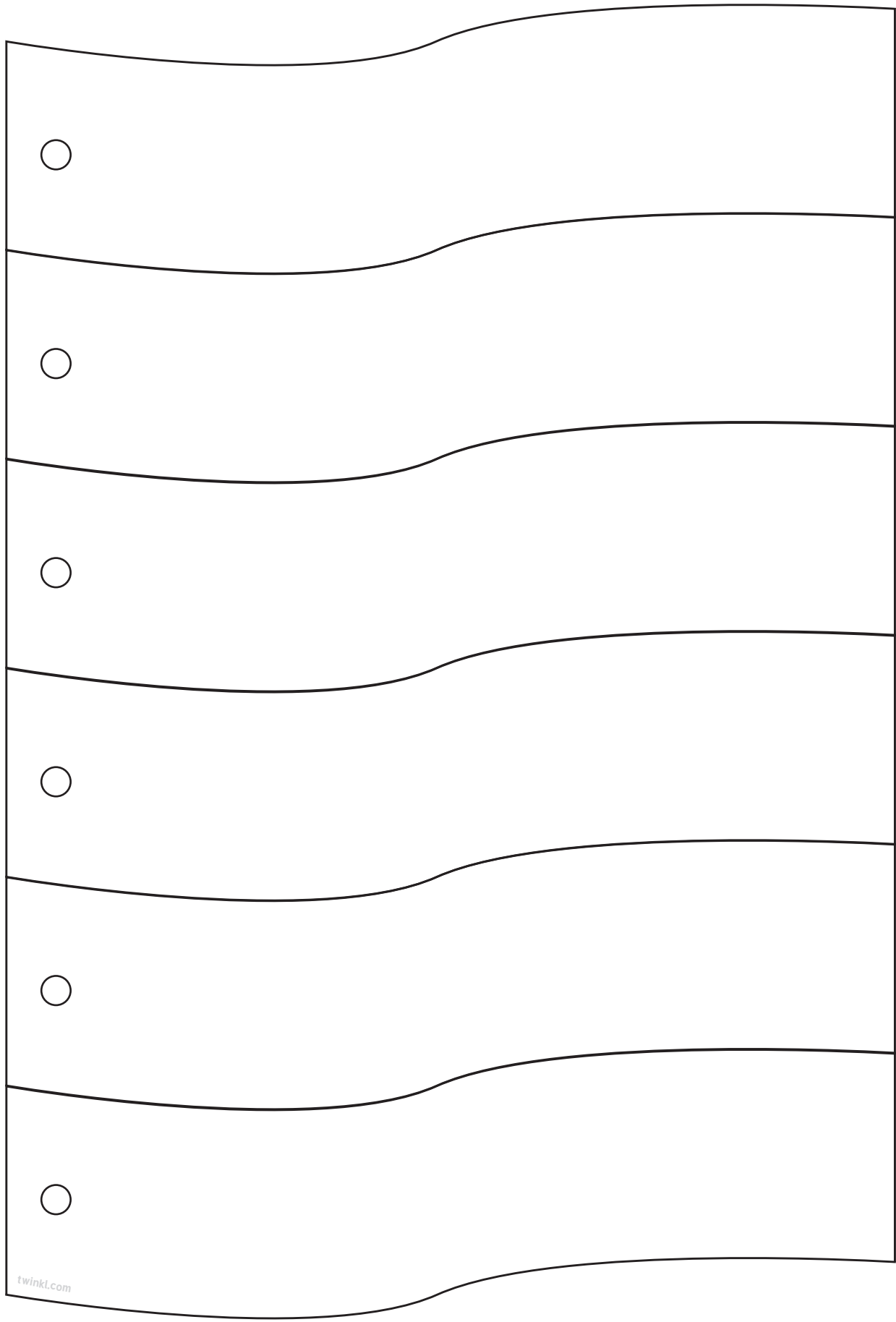

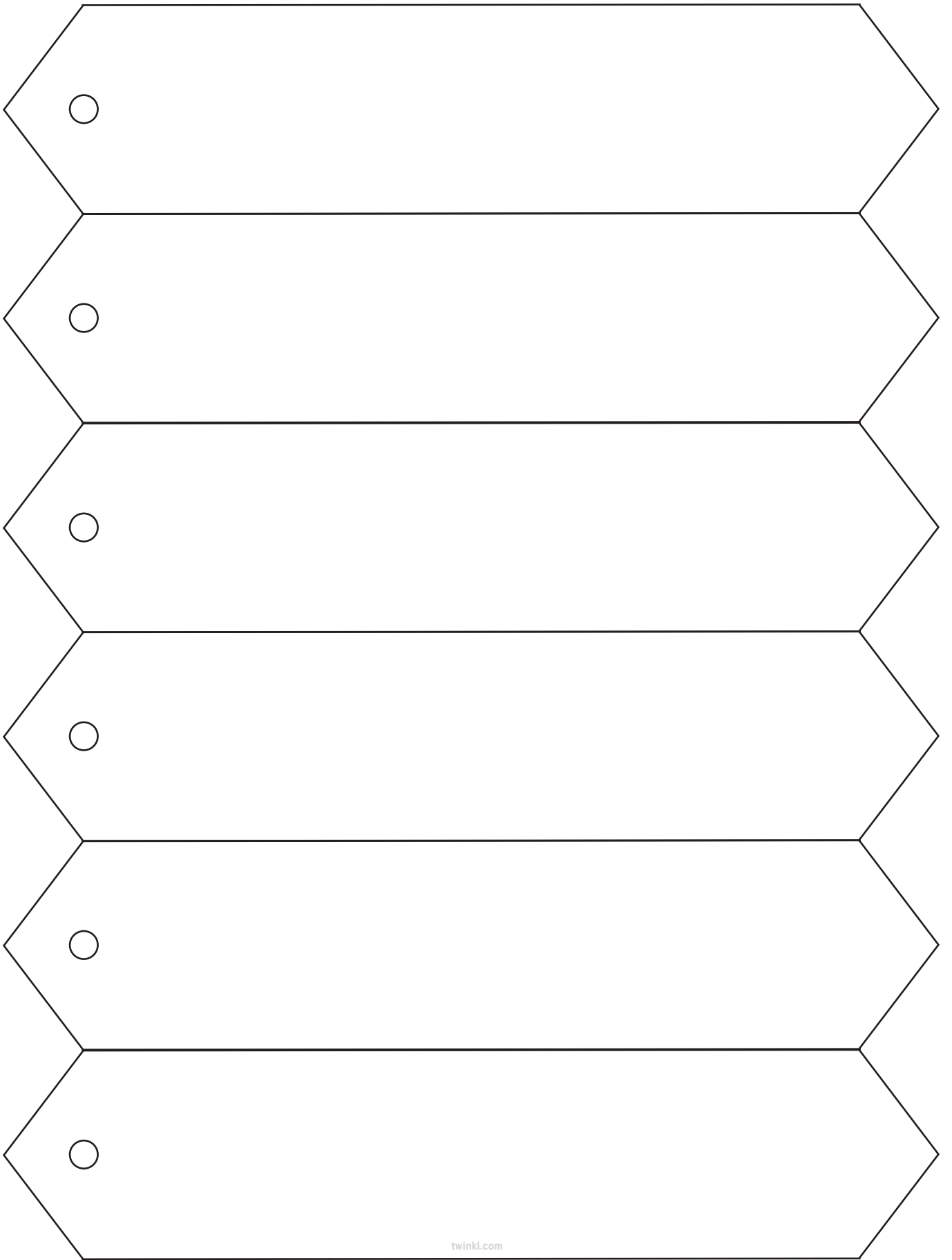

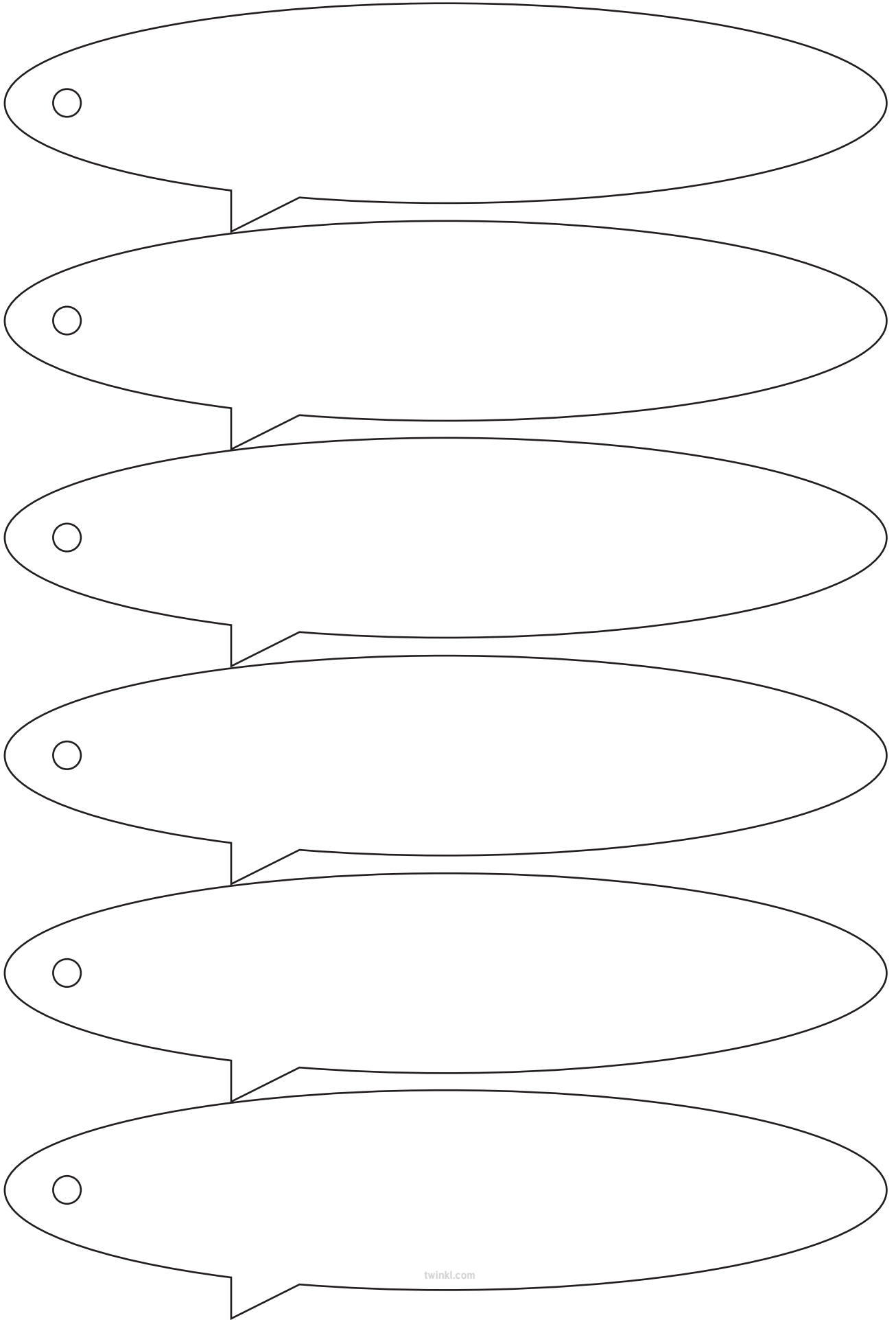

A vertical list of seven identical horizontal rectangular boxes, each with a small circle on the left side and a large arrowhead pointing to the right on the right side. The boxes are arranged in a column, one above the other, with a small gap between each box. The circles are positioned in the upper-left corner of each box, and the arrowheads are positioned at the right edge of each box.

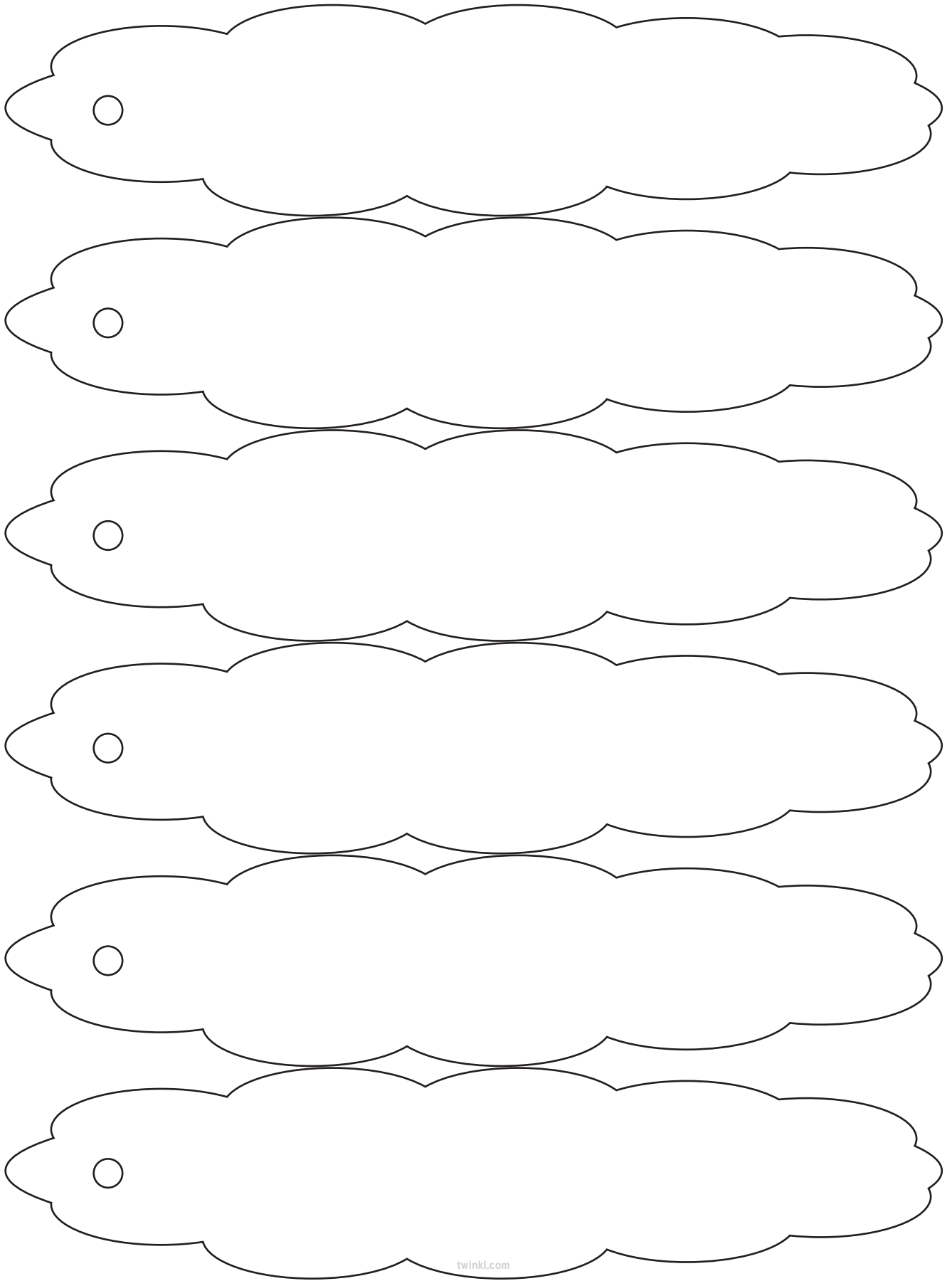

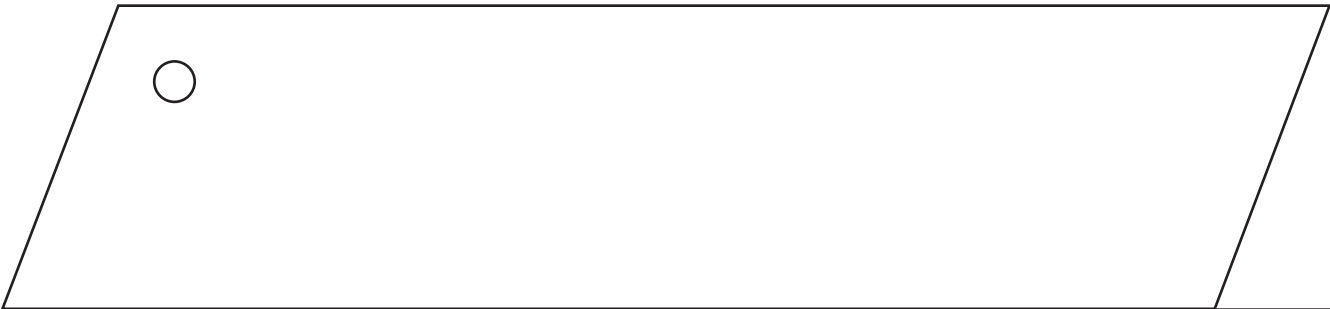

Enveloppes et pochettes

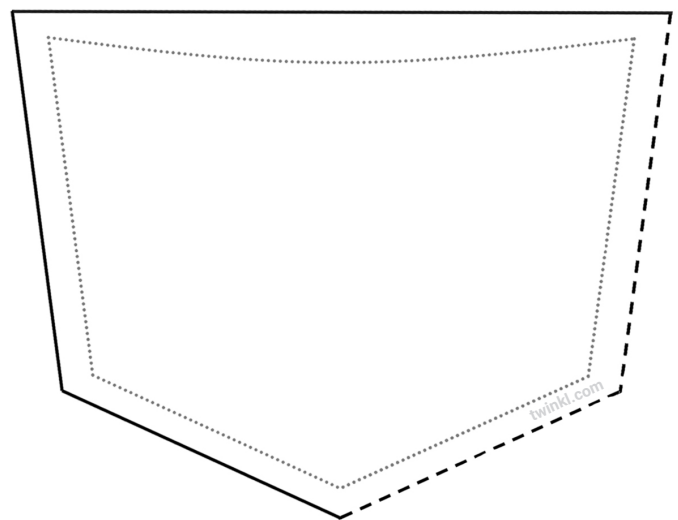
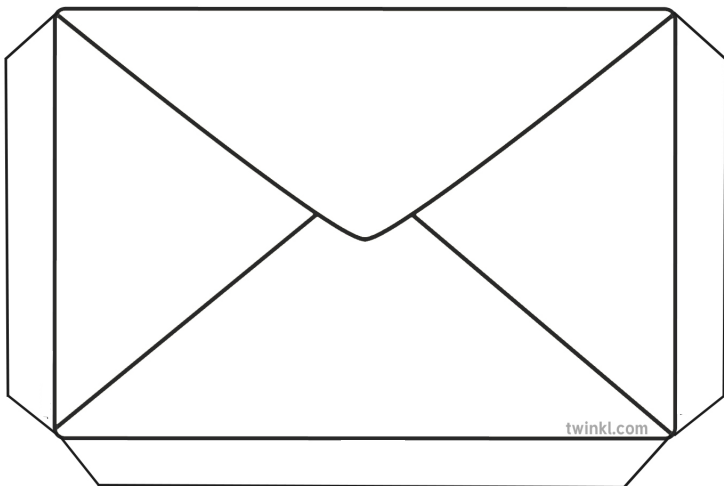
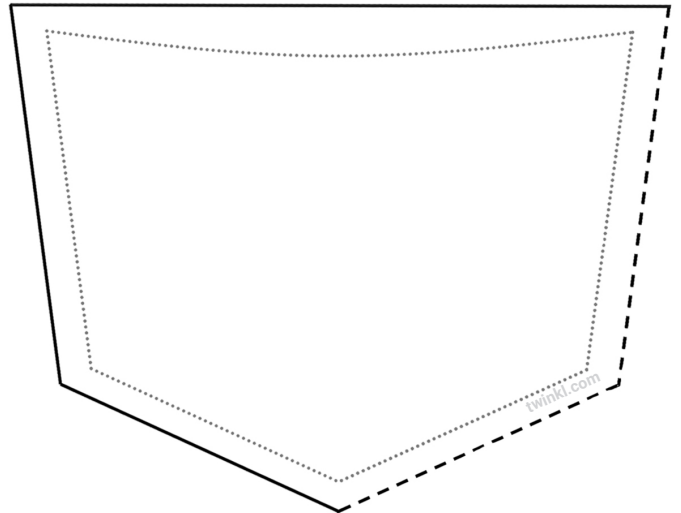
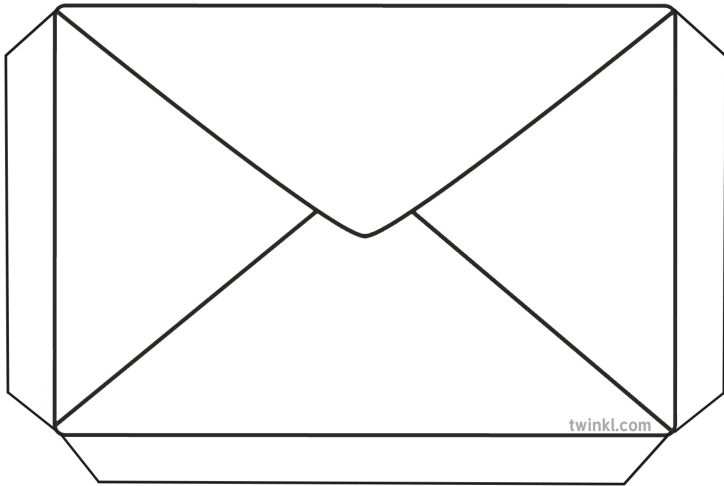
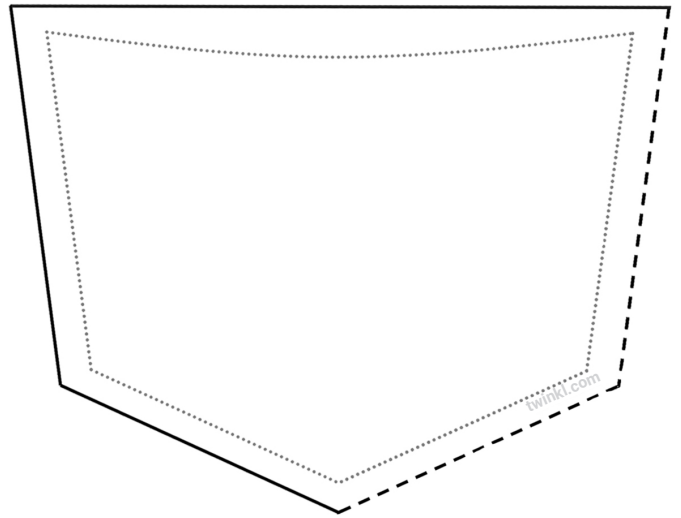
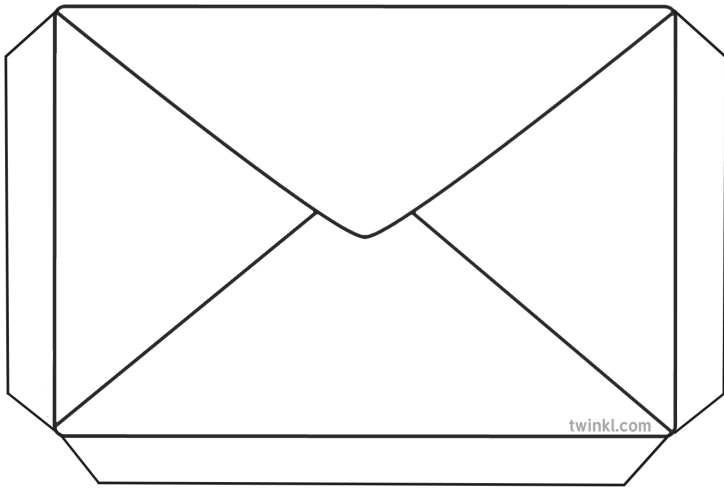

Pétales pour projets ou lapbooks

Imprimez et découpez les pétales pour vos projets ou lapbooks. Dessinez ou écrivez le sujet de votre projet au milieu des pétales et écrivez des faits, informations ou questions sur les rabats. Pliez et imbriquez les rabats puis fixez-les sur votre projet ou faites une pochette pour les ranger.

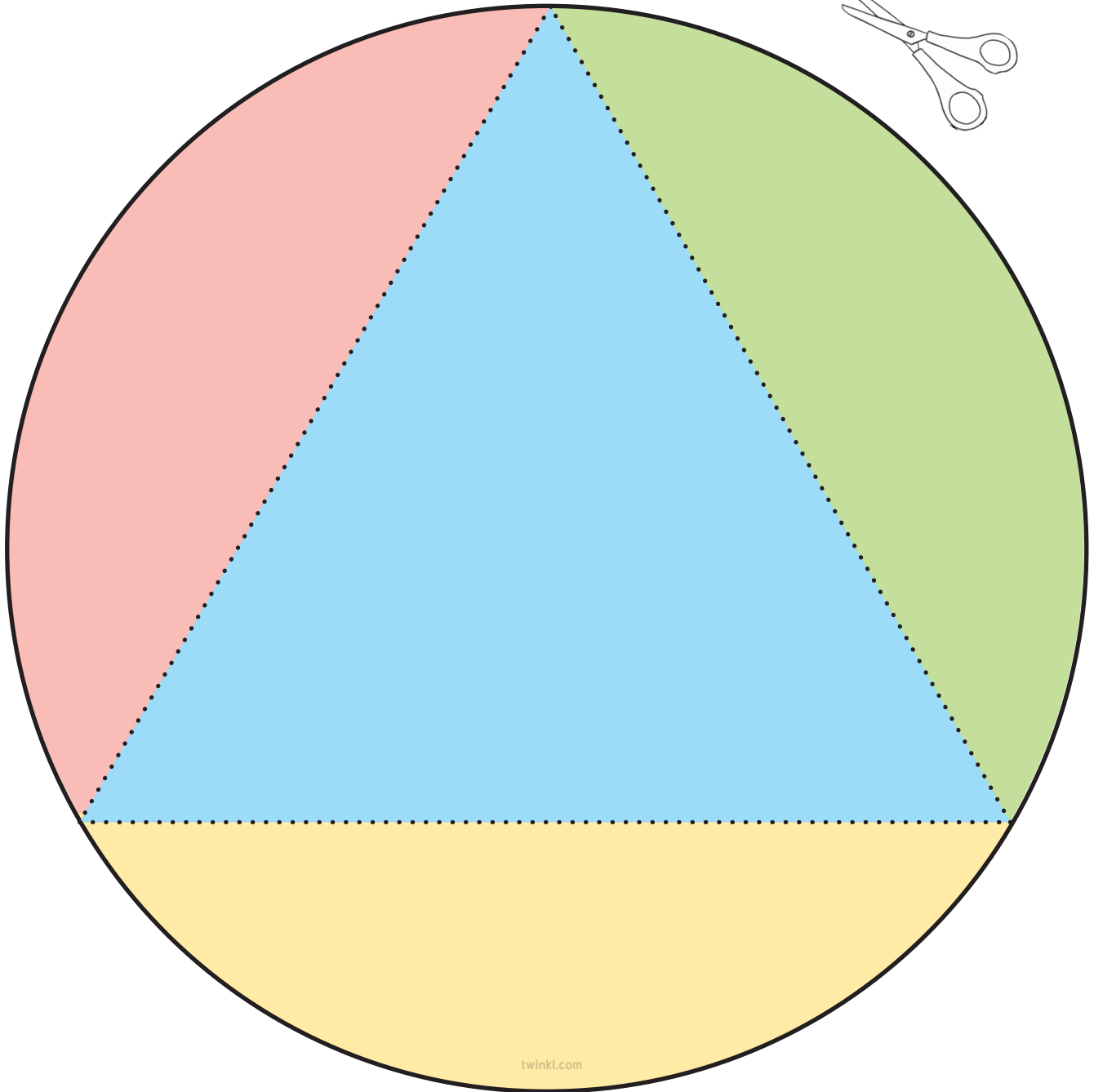
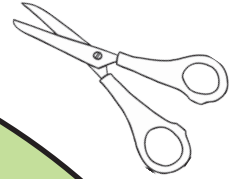

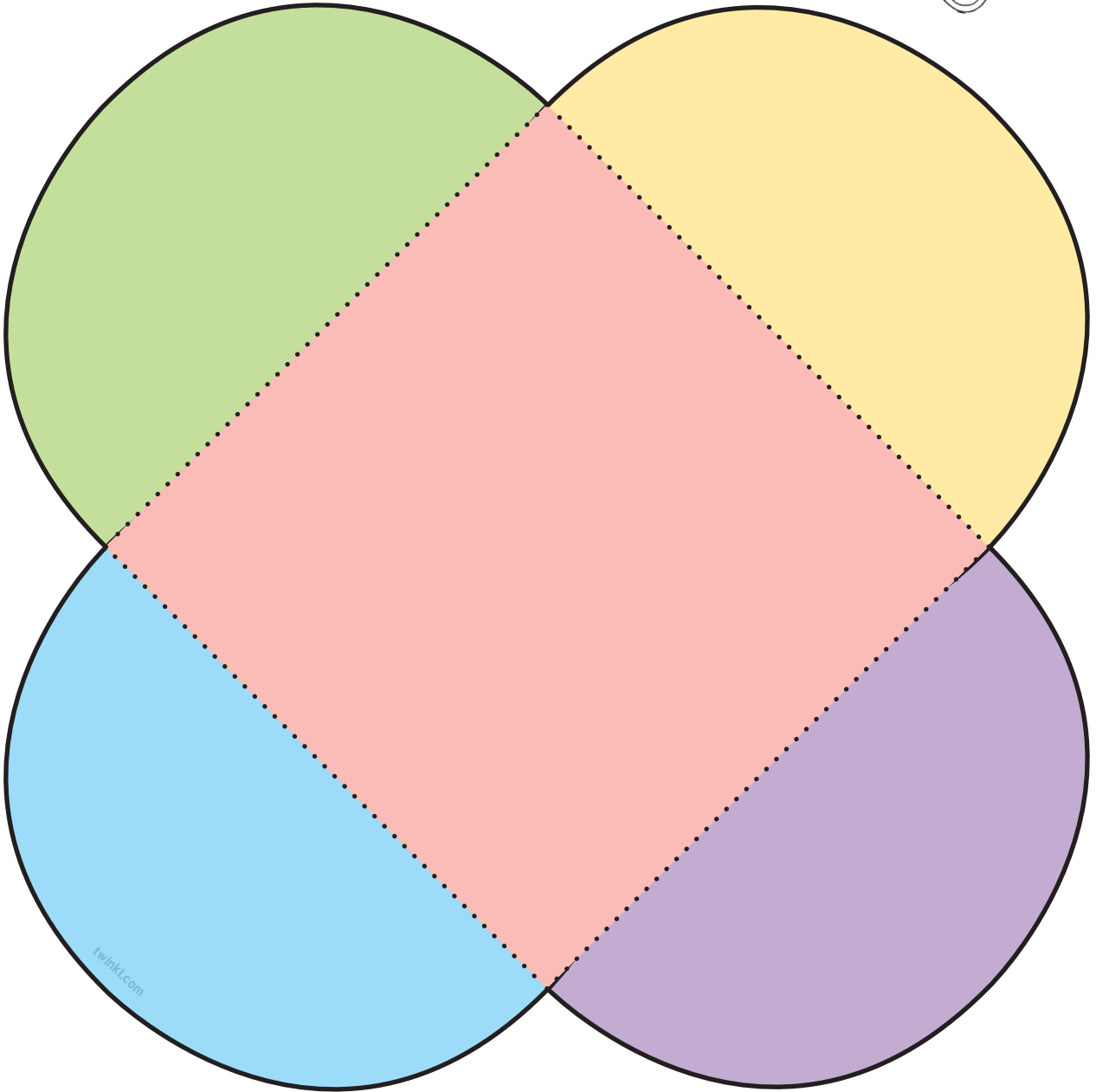
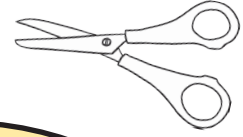

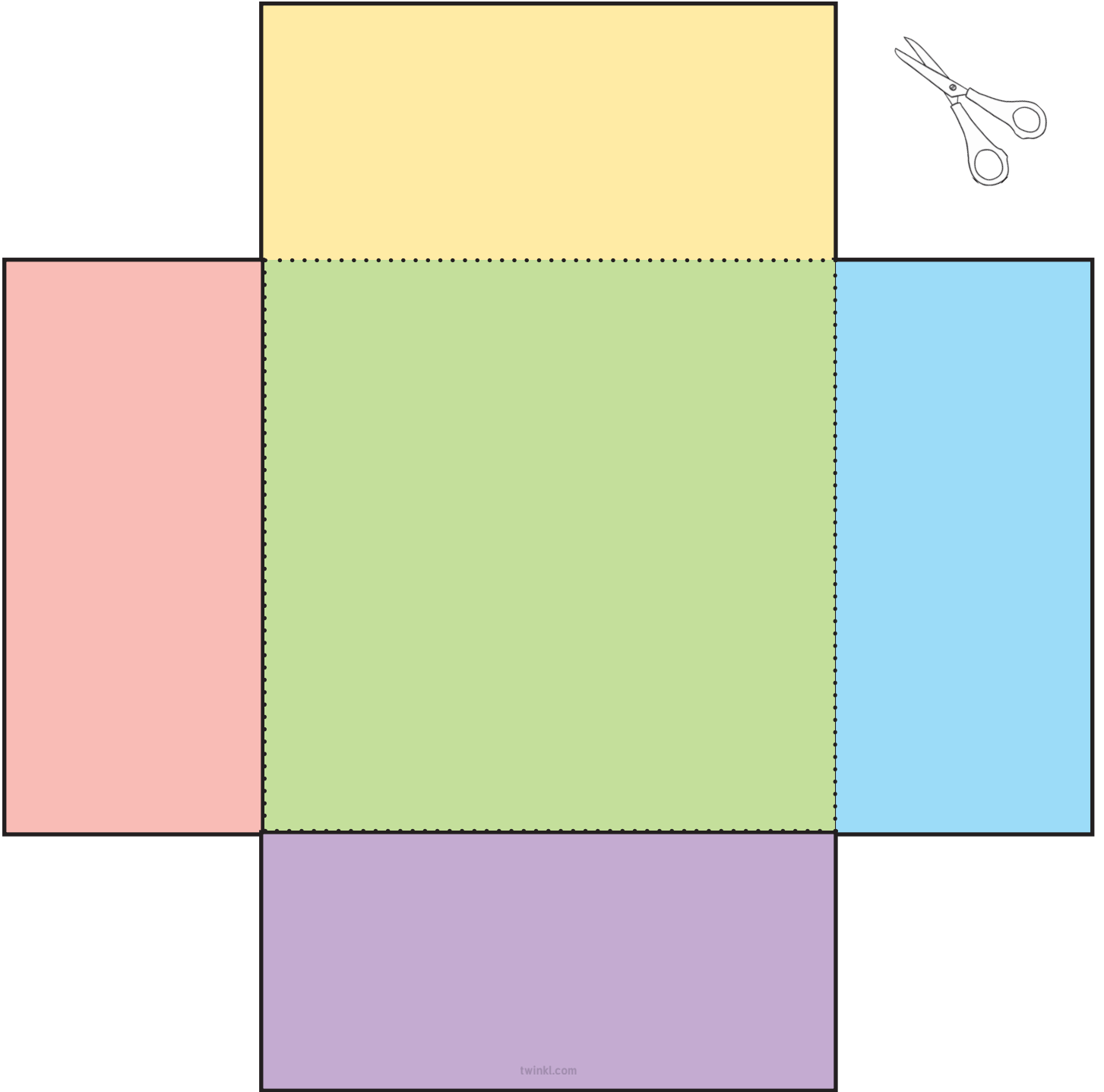

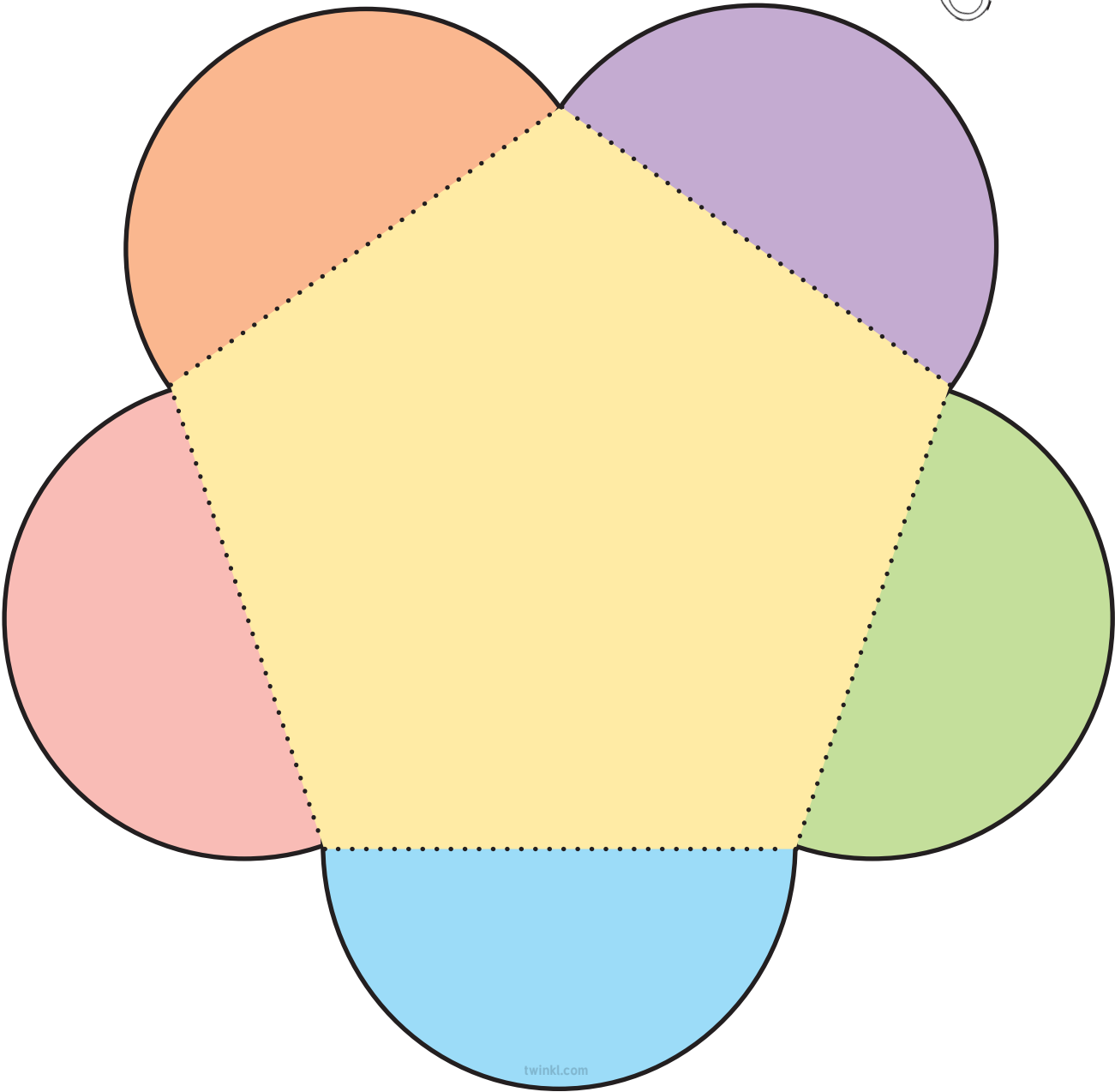
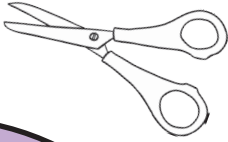

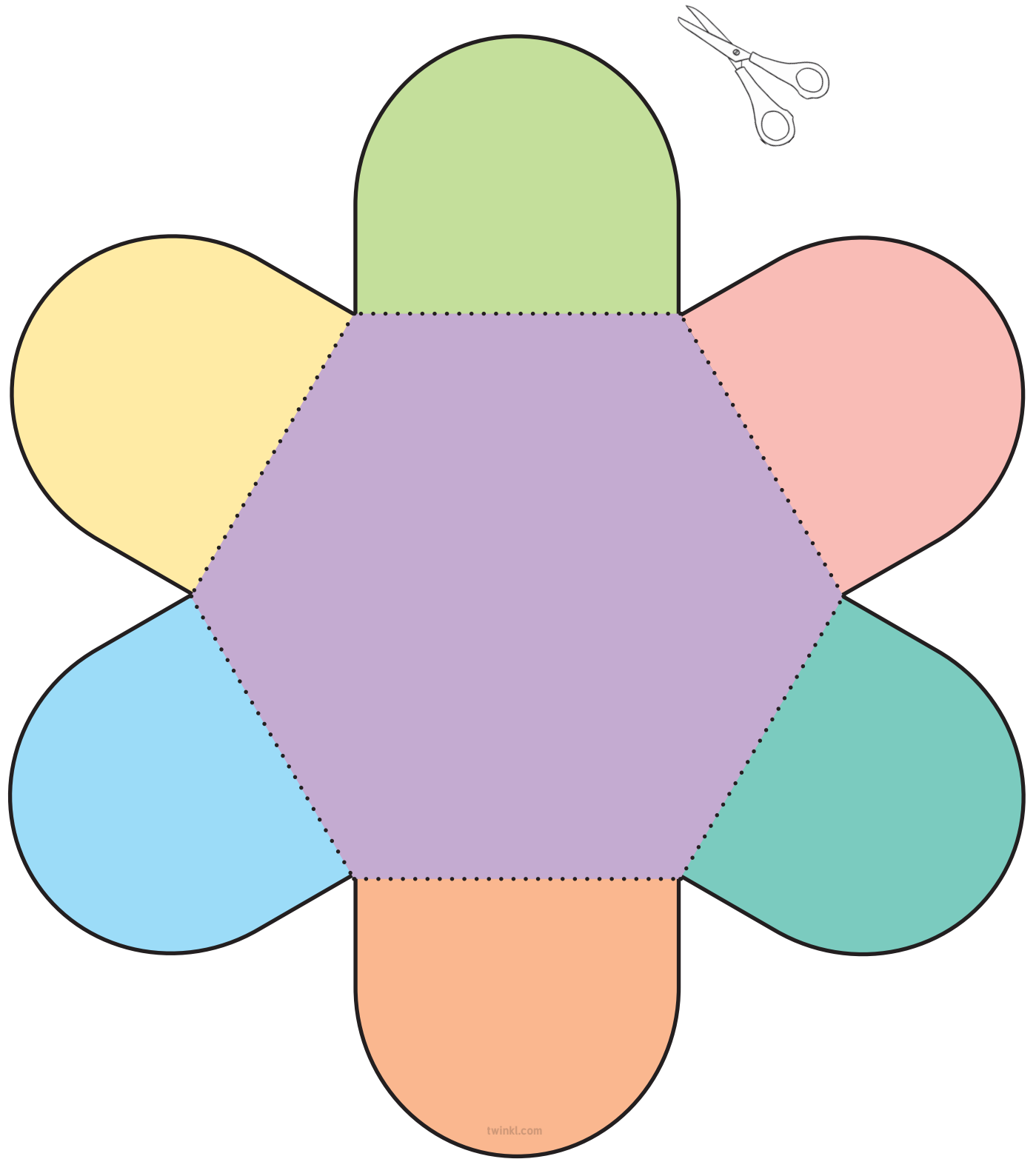

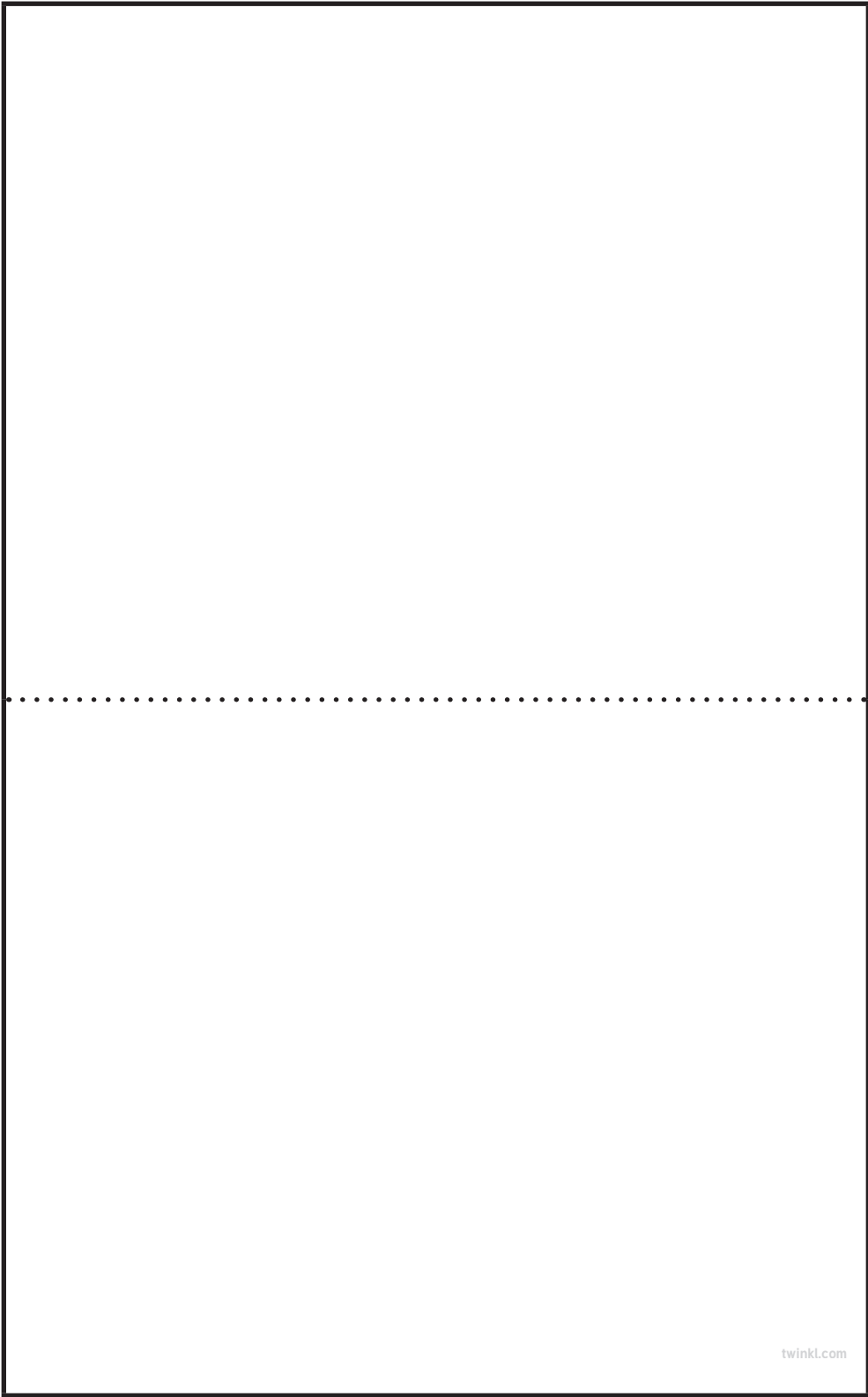

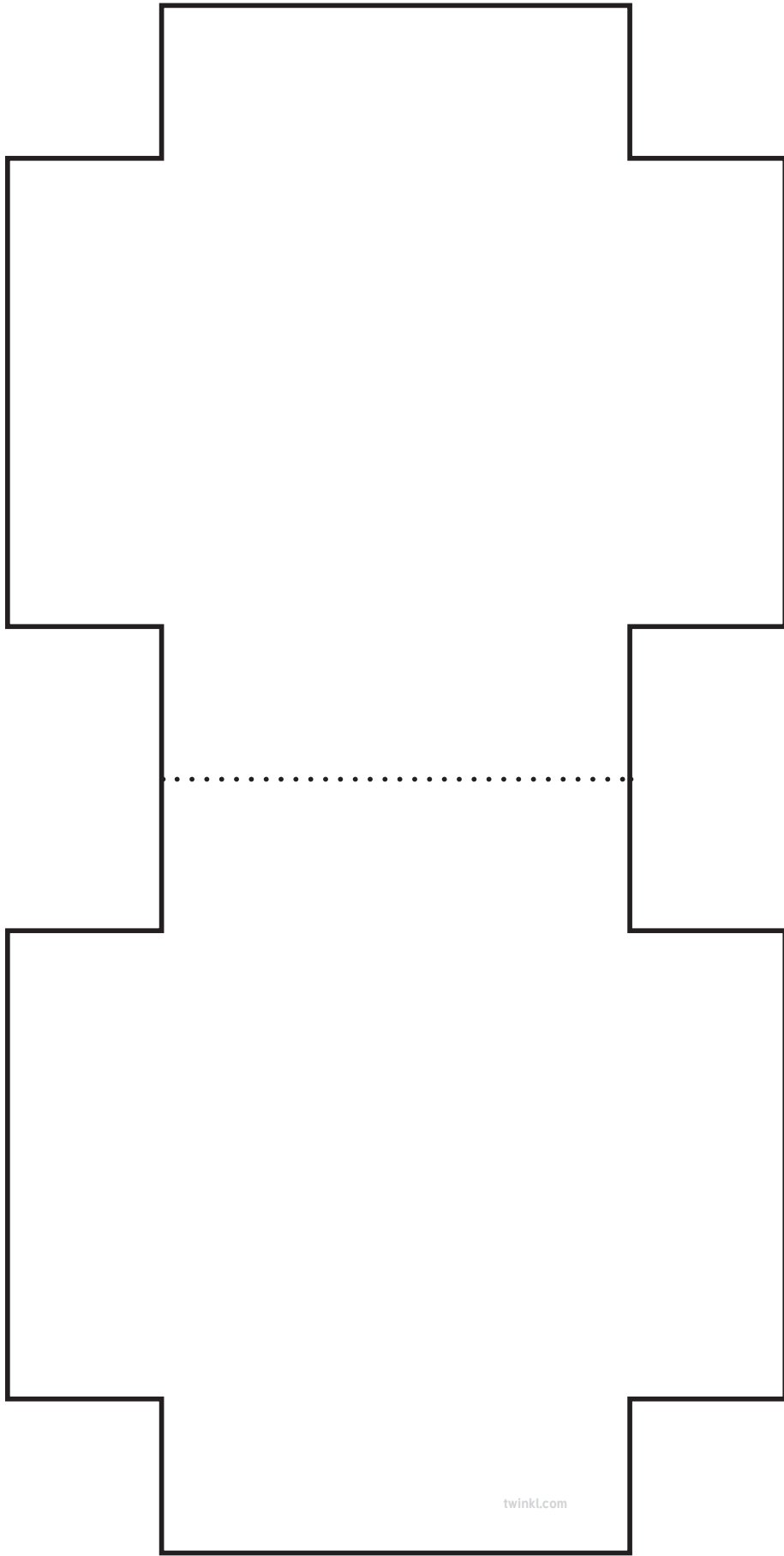

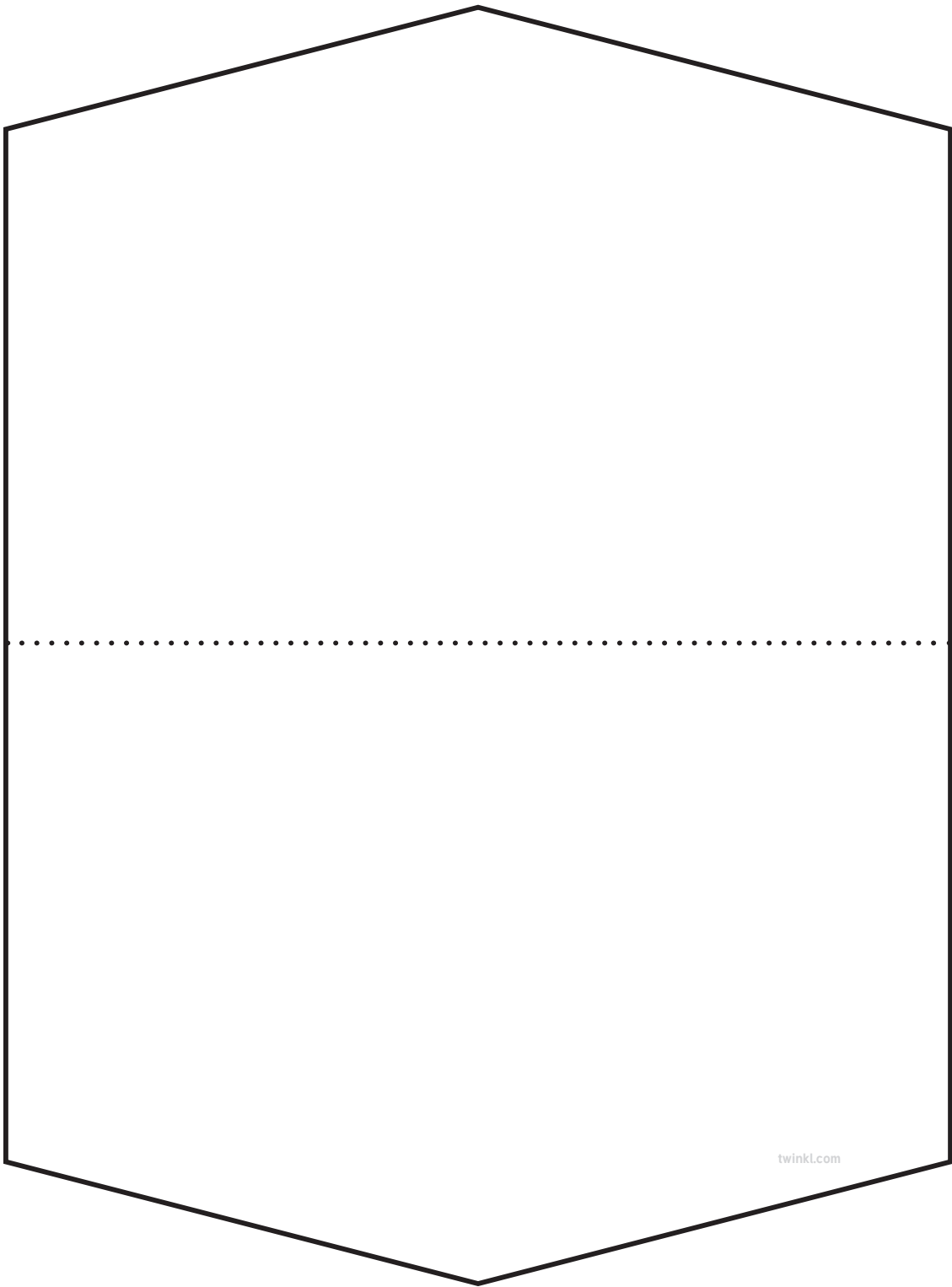

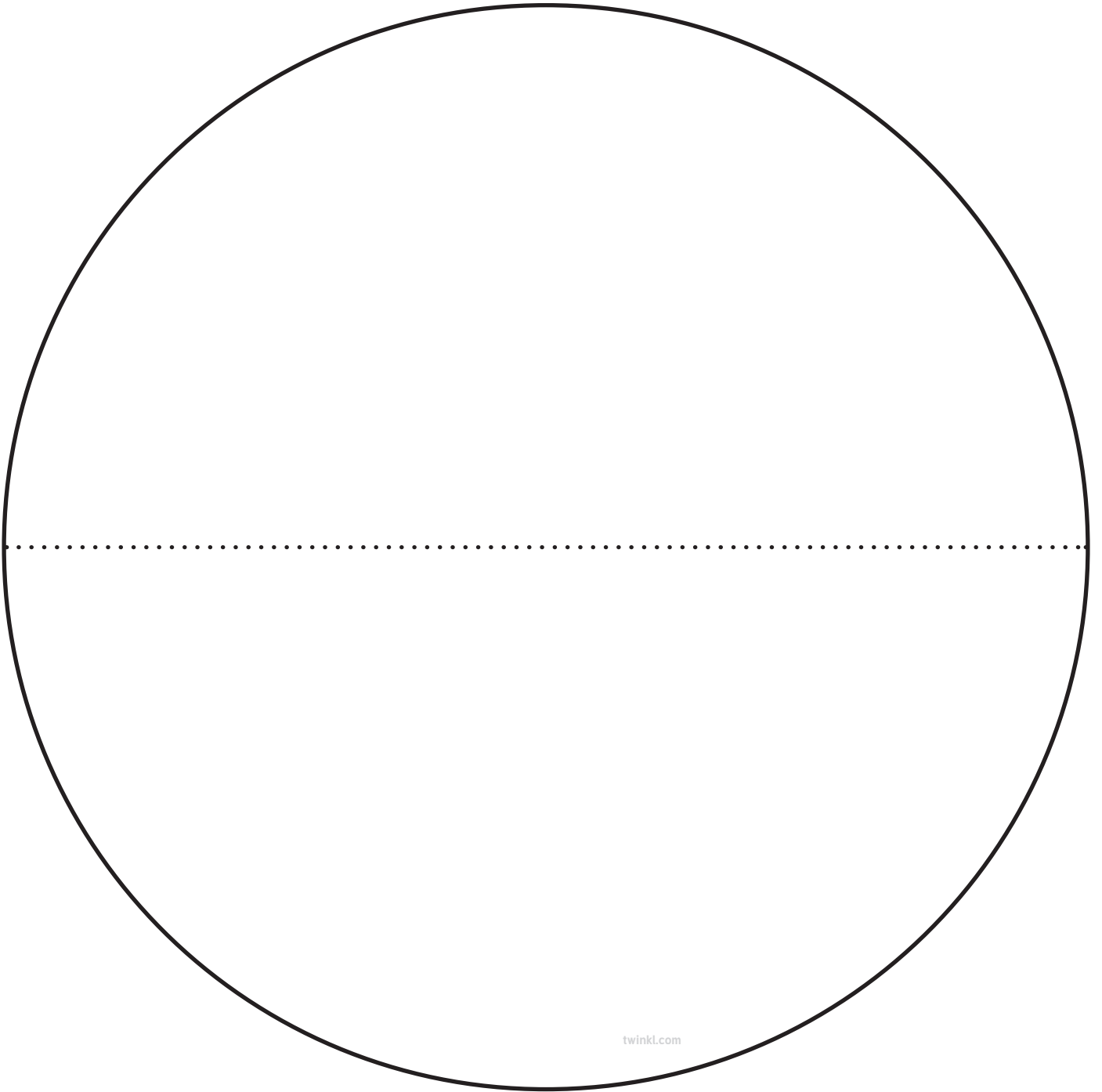

Blank handwriting practice box with a dotted midline. [twinkl.com](https://www.twinkl.com)

Blank handwriting practice box with a dotted midline. [twinkl.com](https://www.twinkl.com)

Blank handwriting practice box with a dotted midline. [twinkl.com](https://www.twinkl.com)

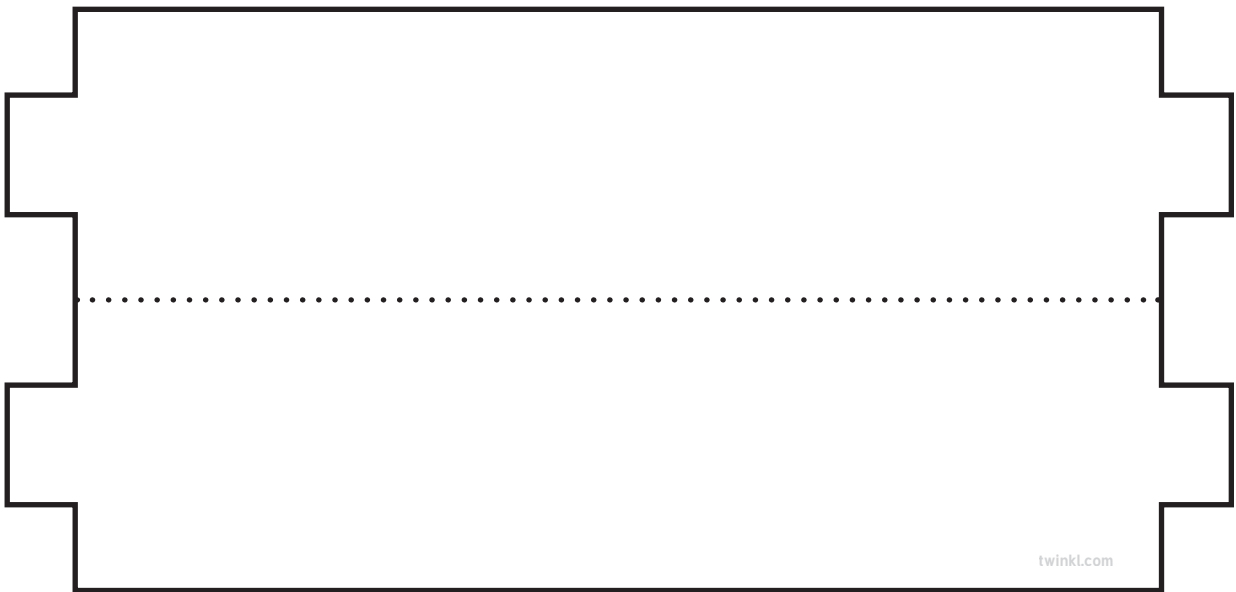
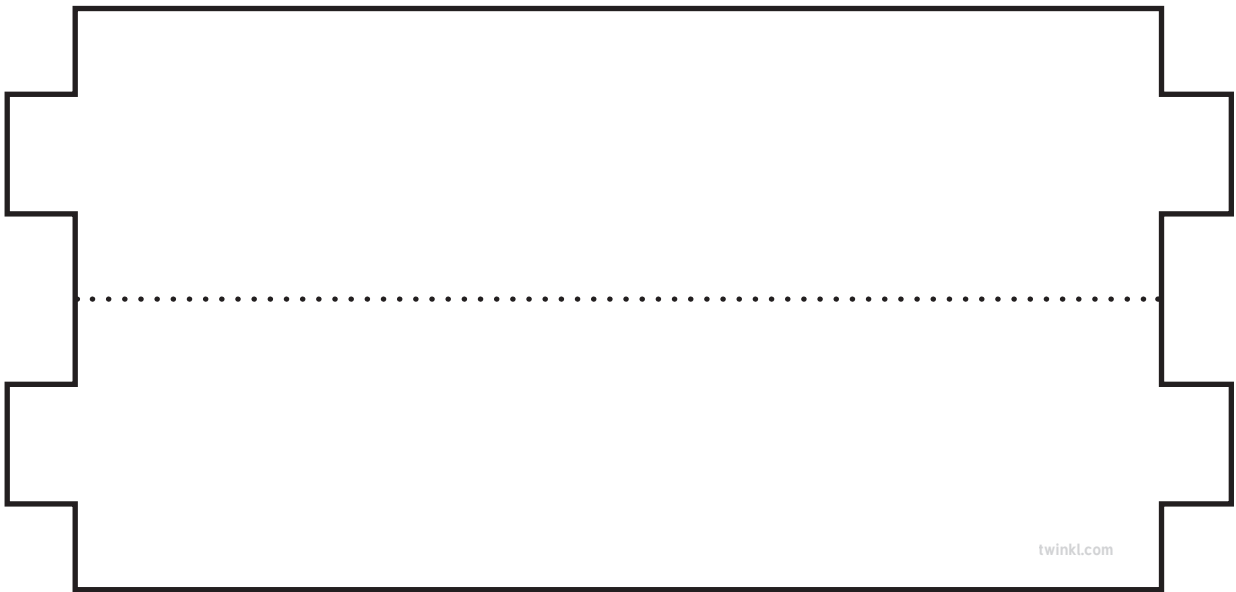
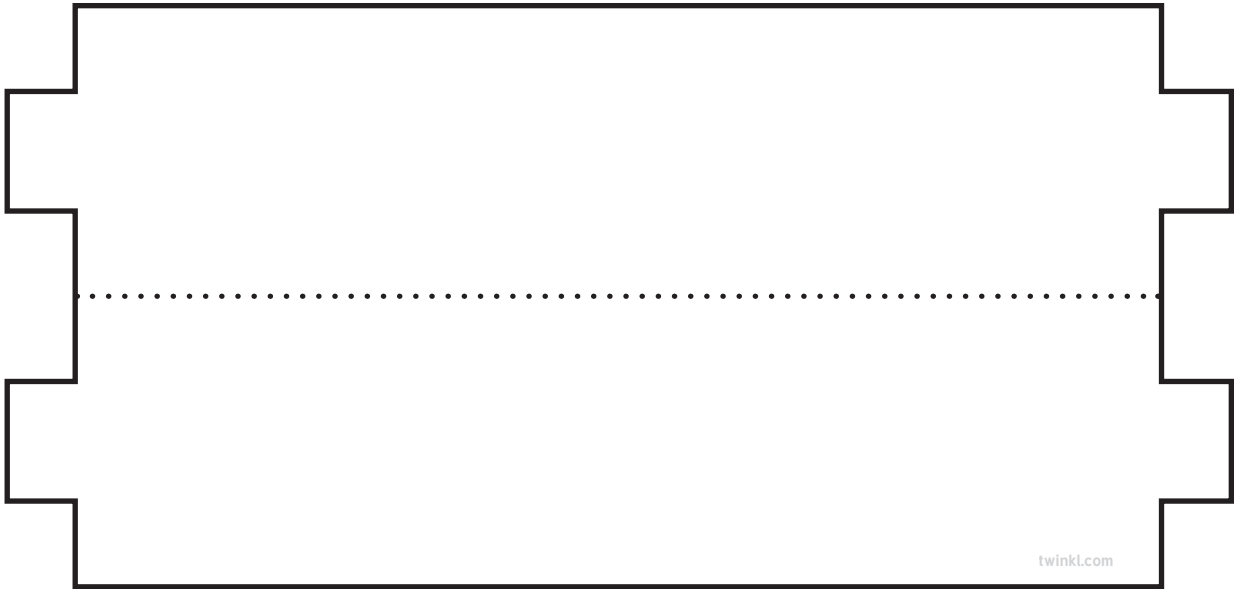

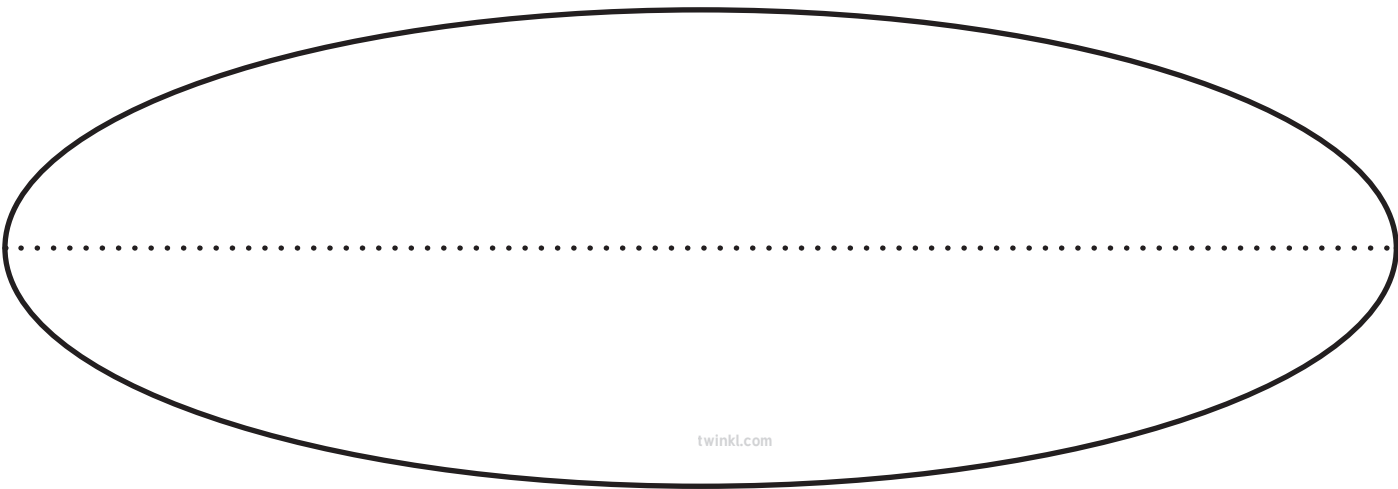
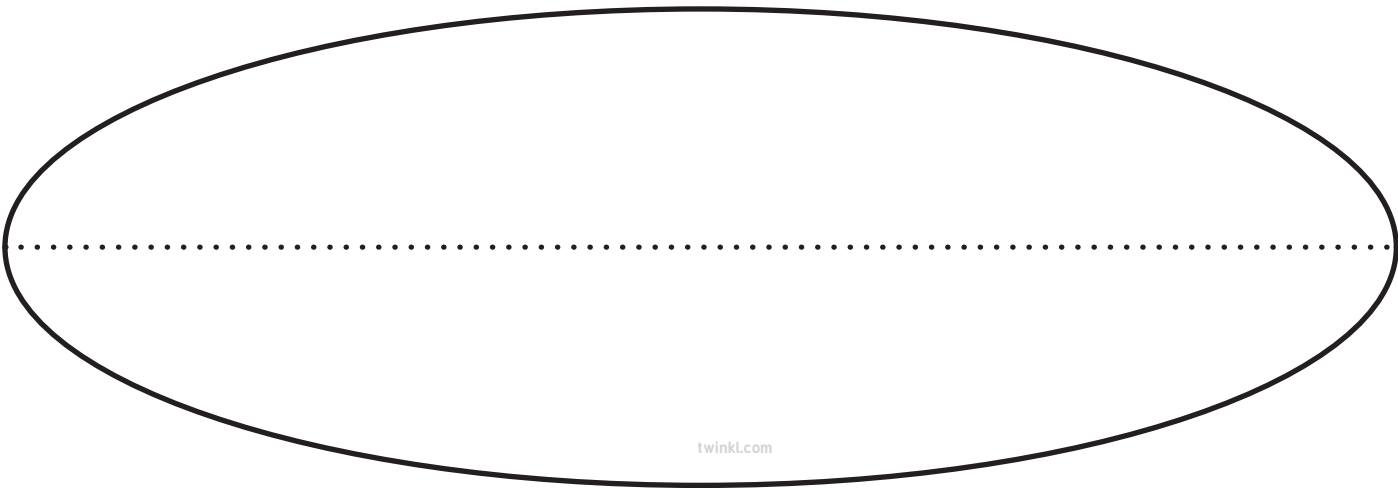
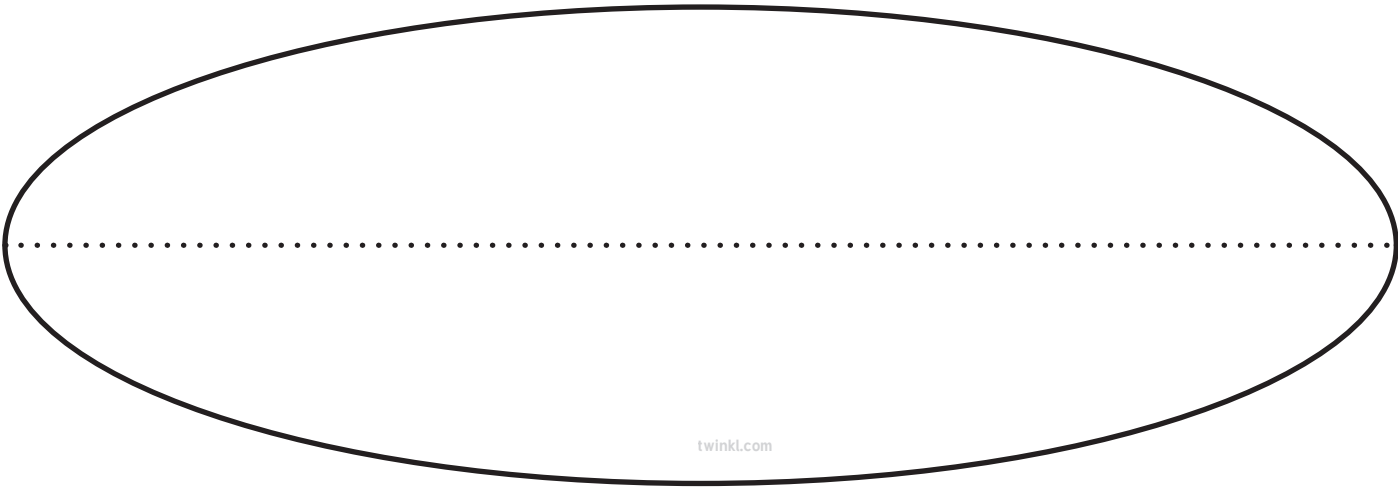

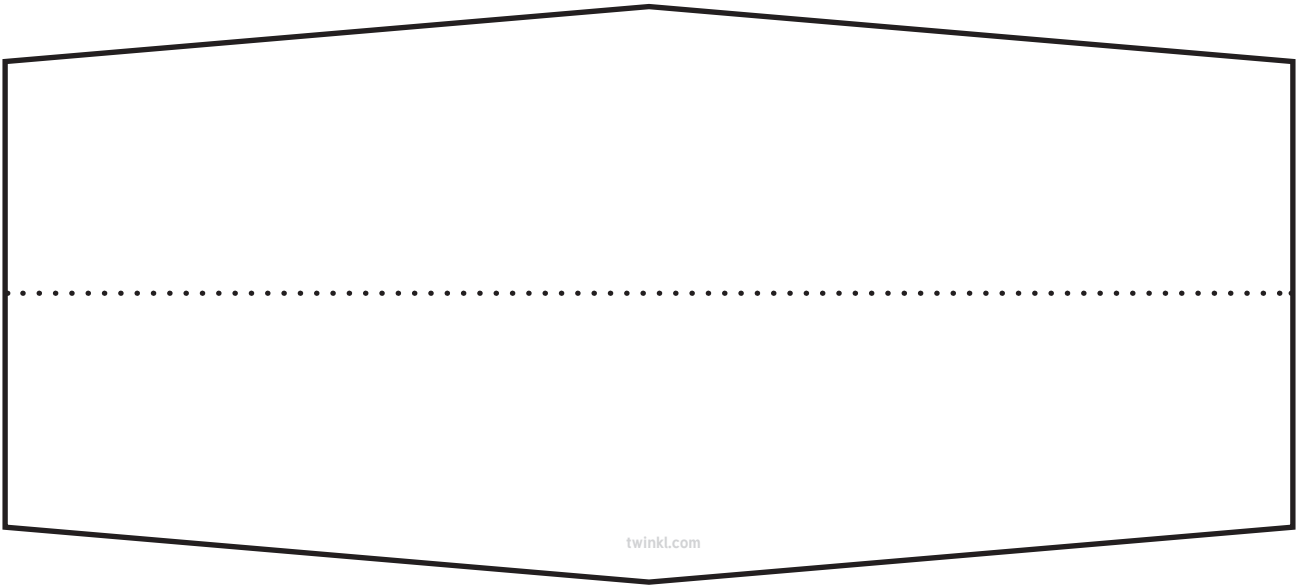

twinkl.com

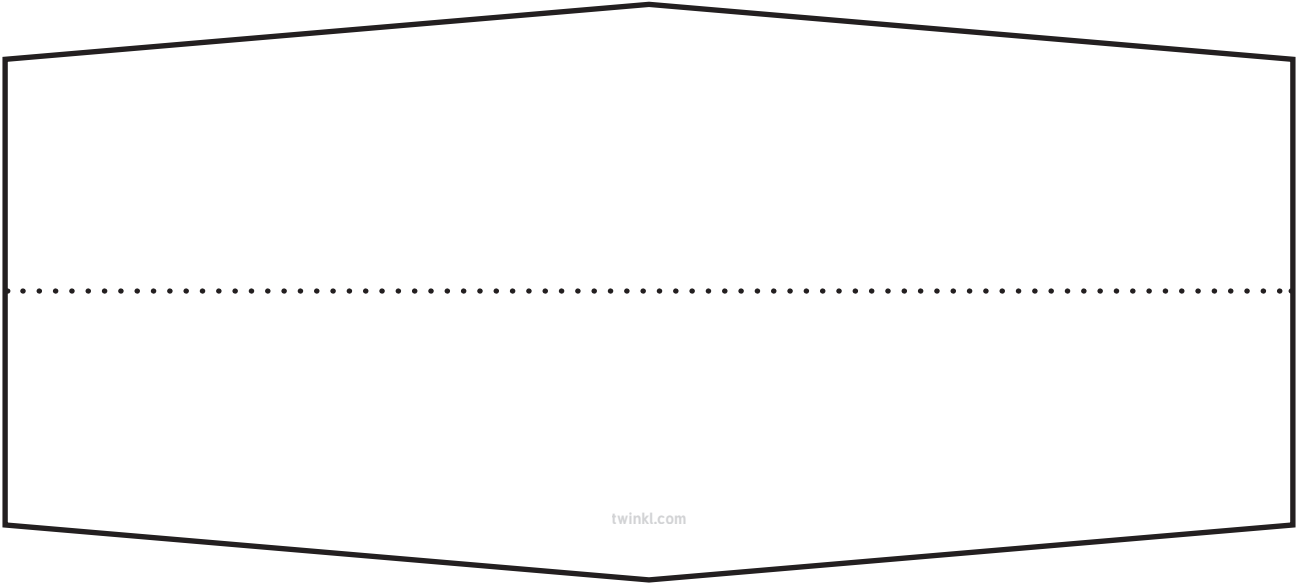

twinkl.com

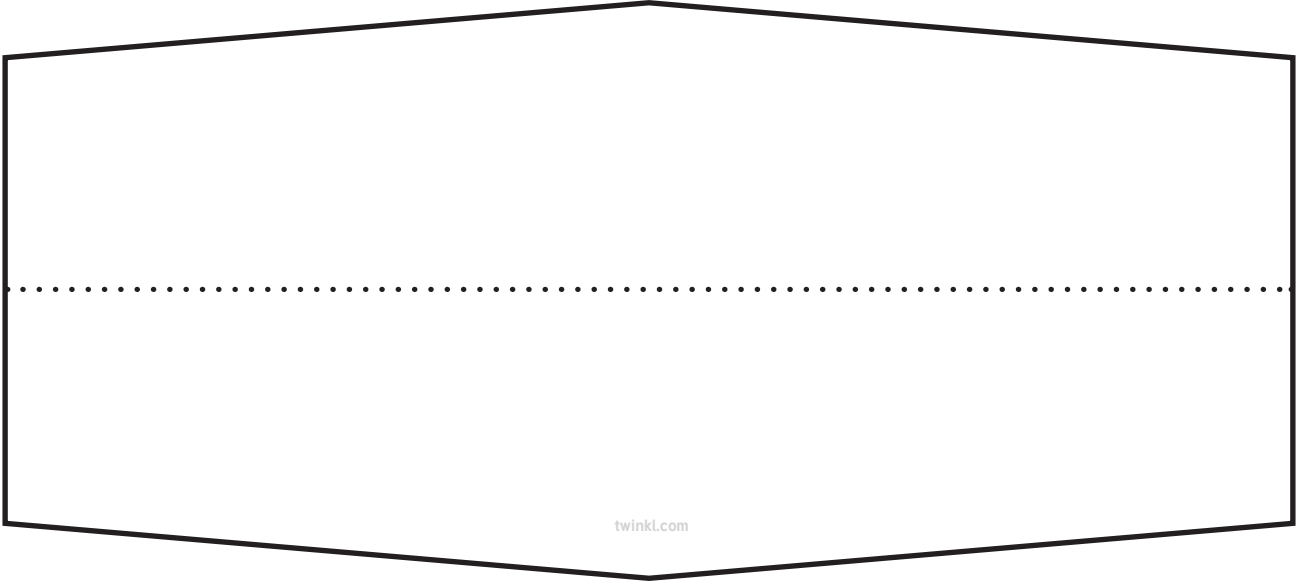

twinkl.com

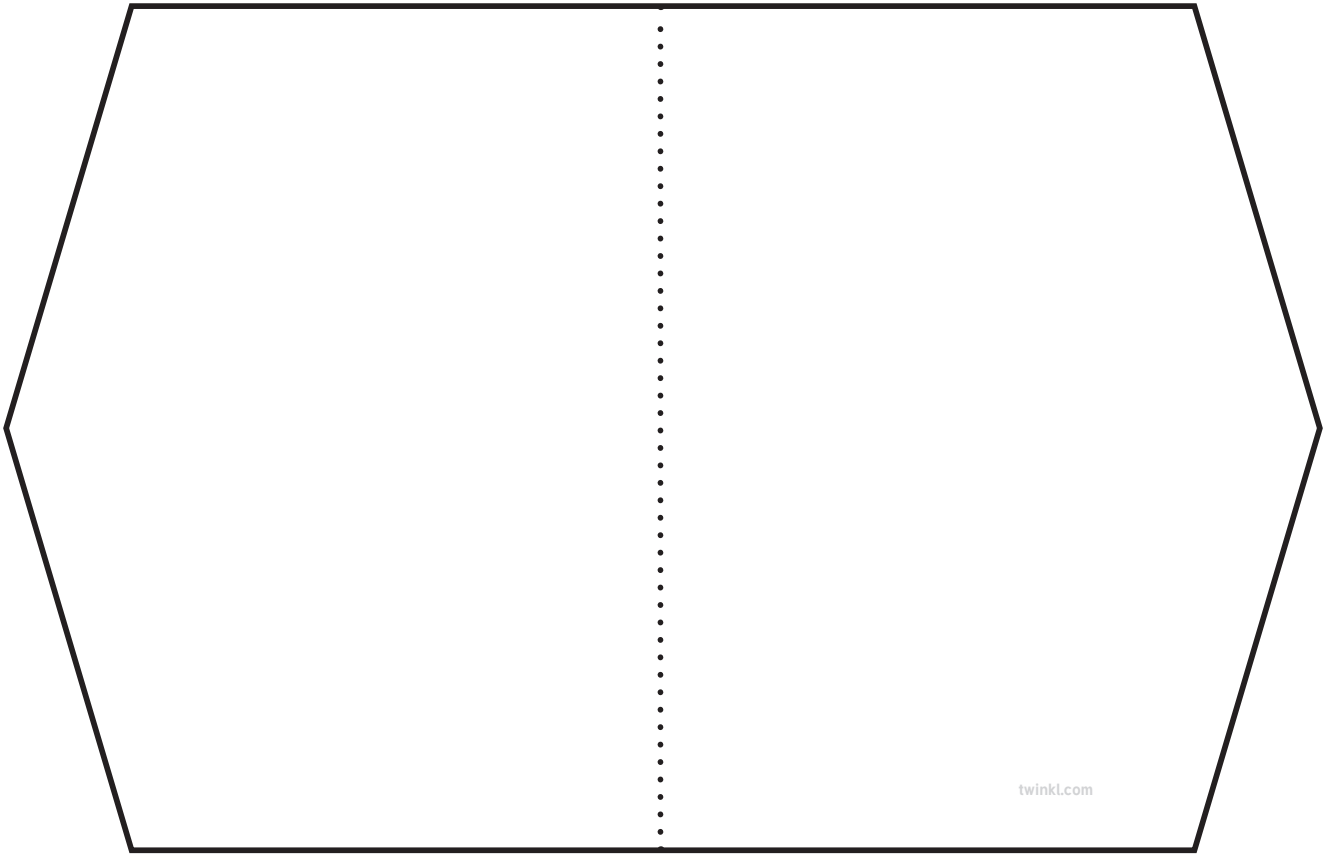

twinkl.com

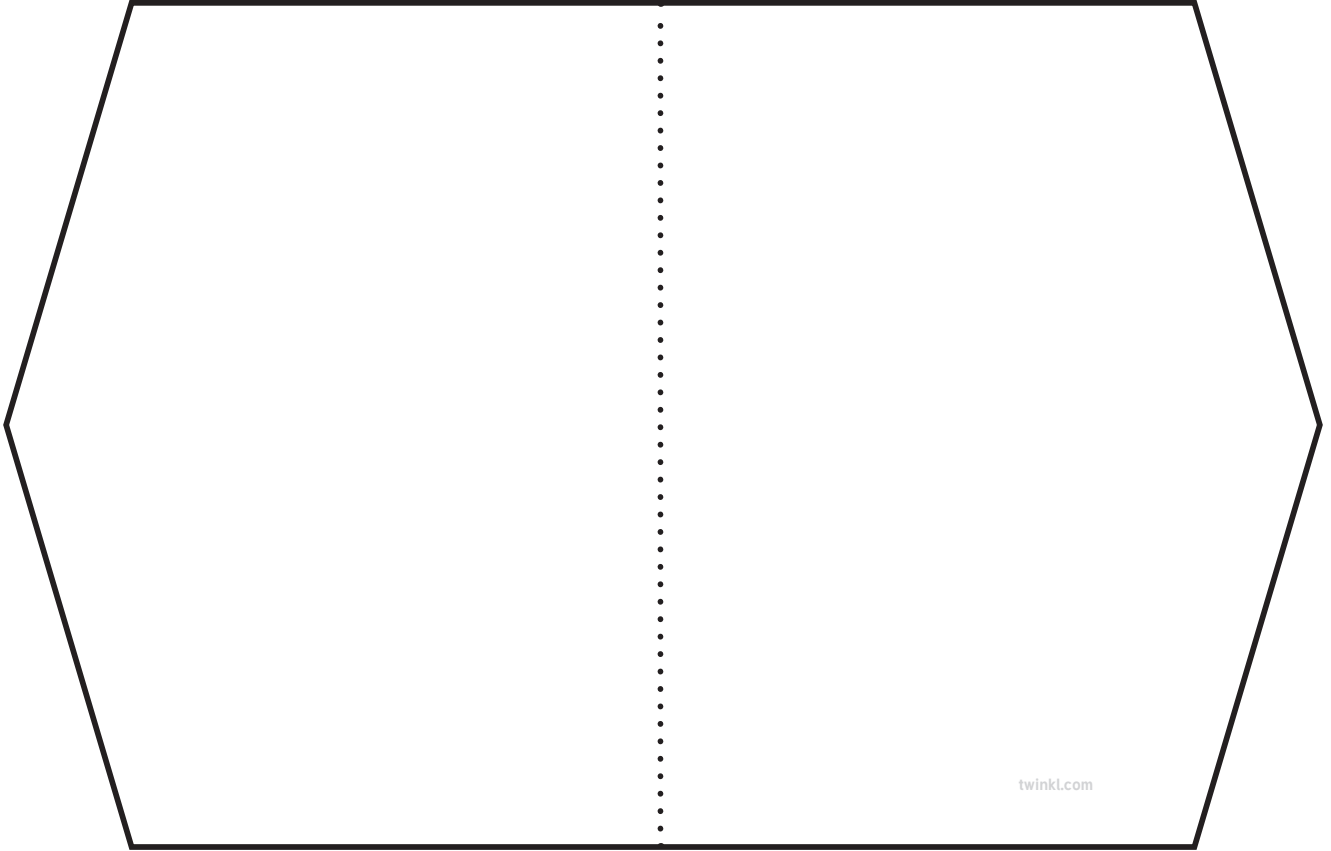

twinkl.com

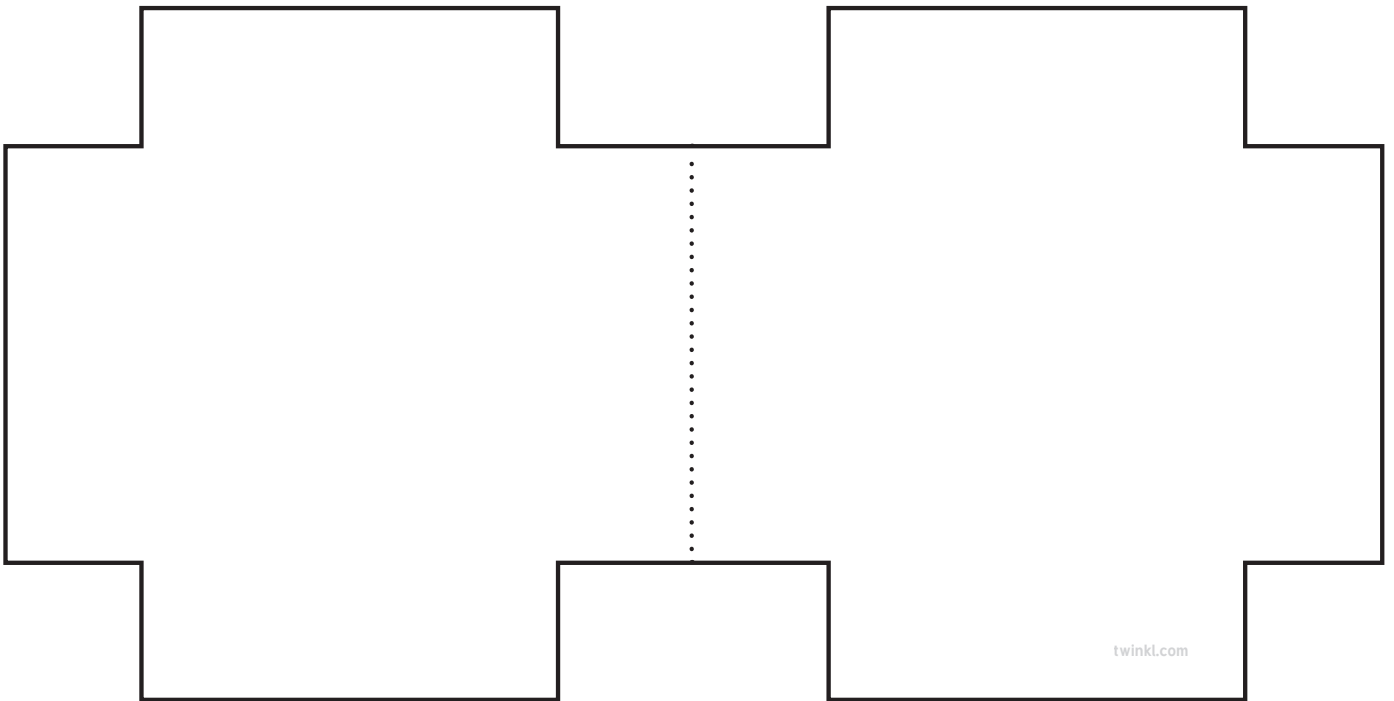
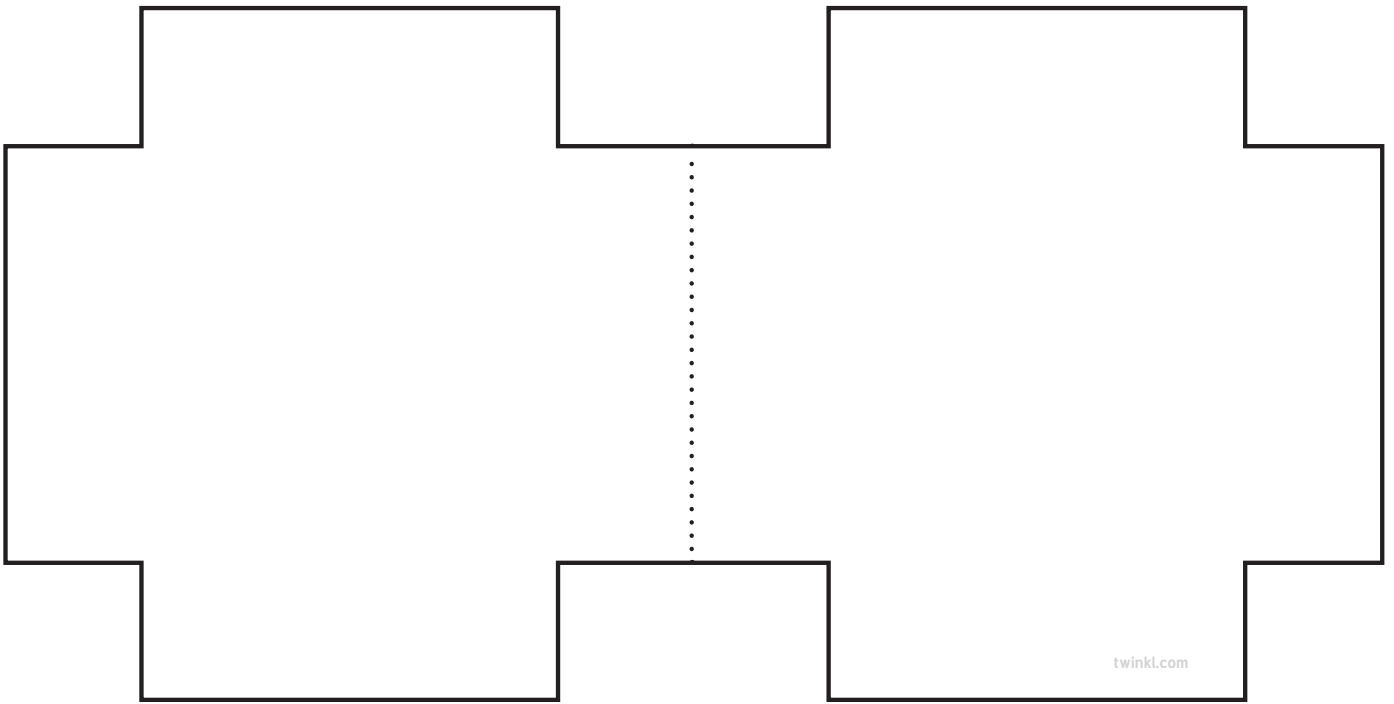

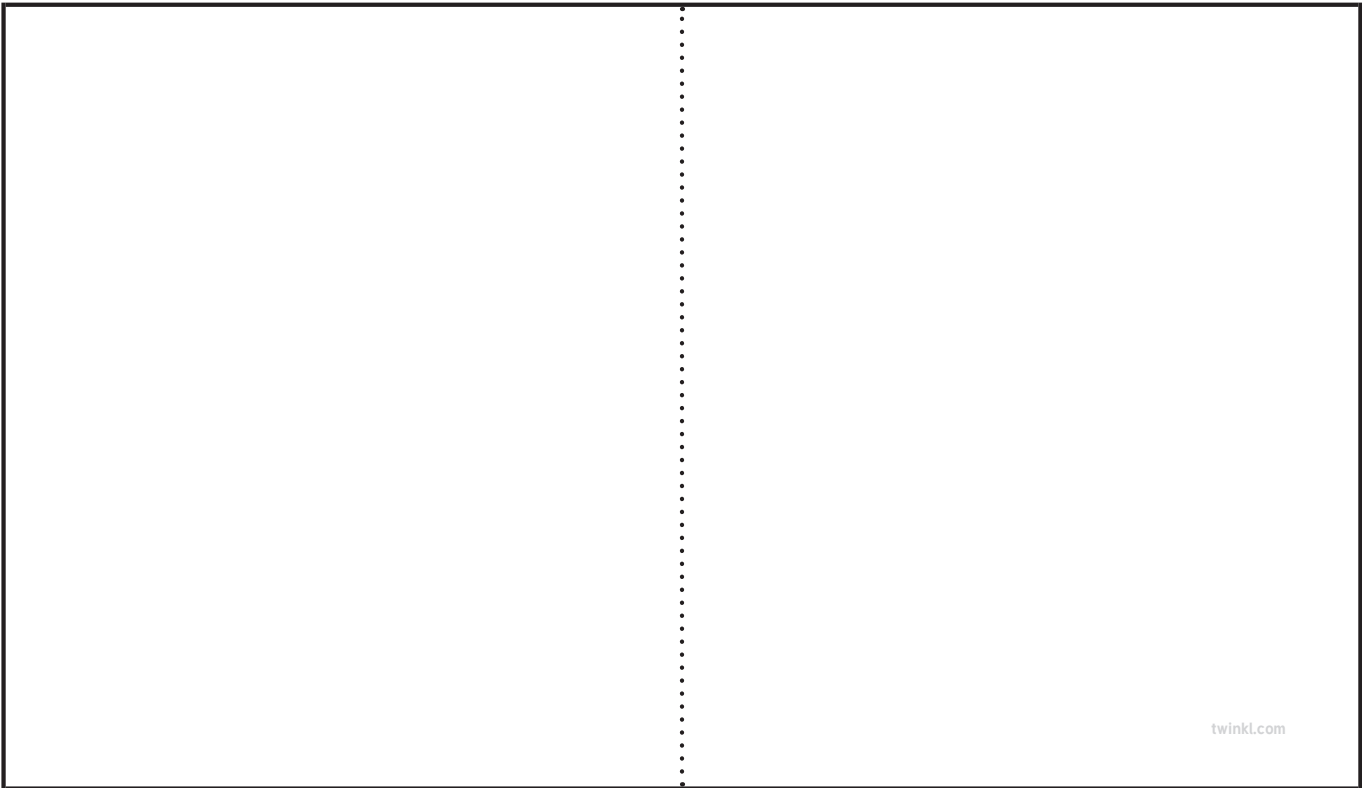
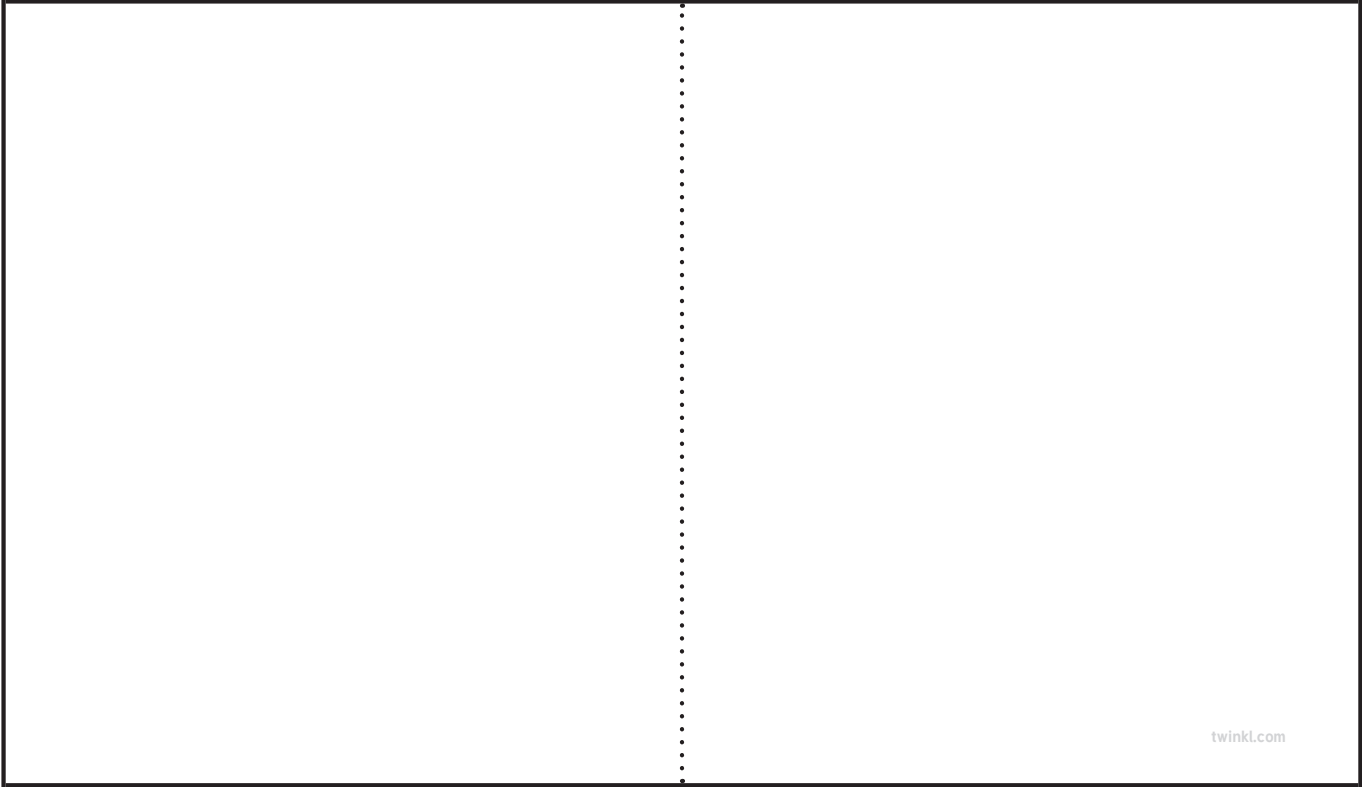

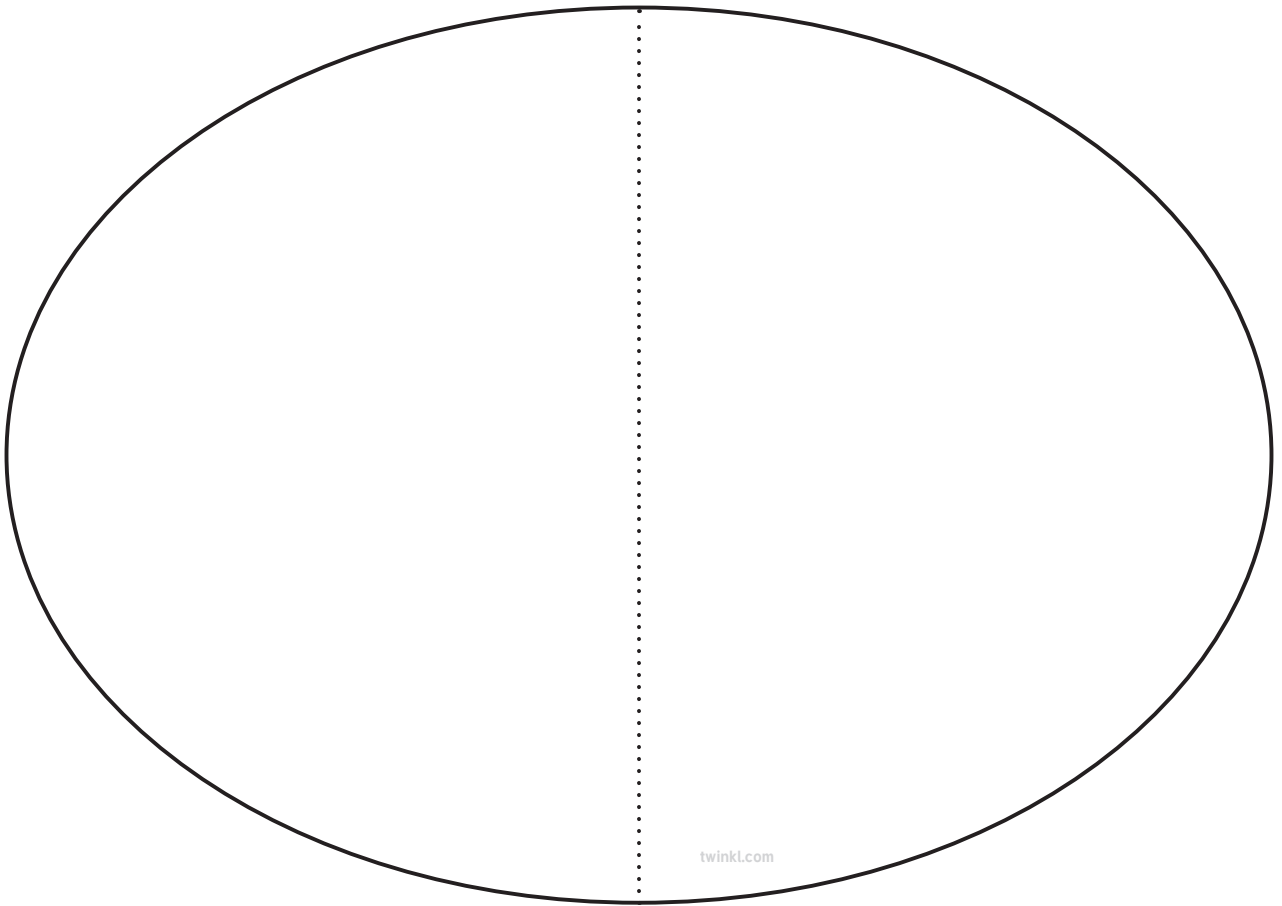

twinkl.com

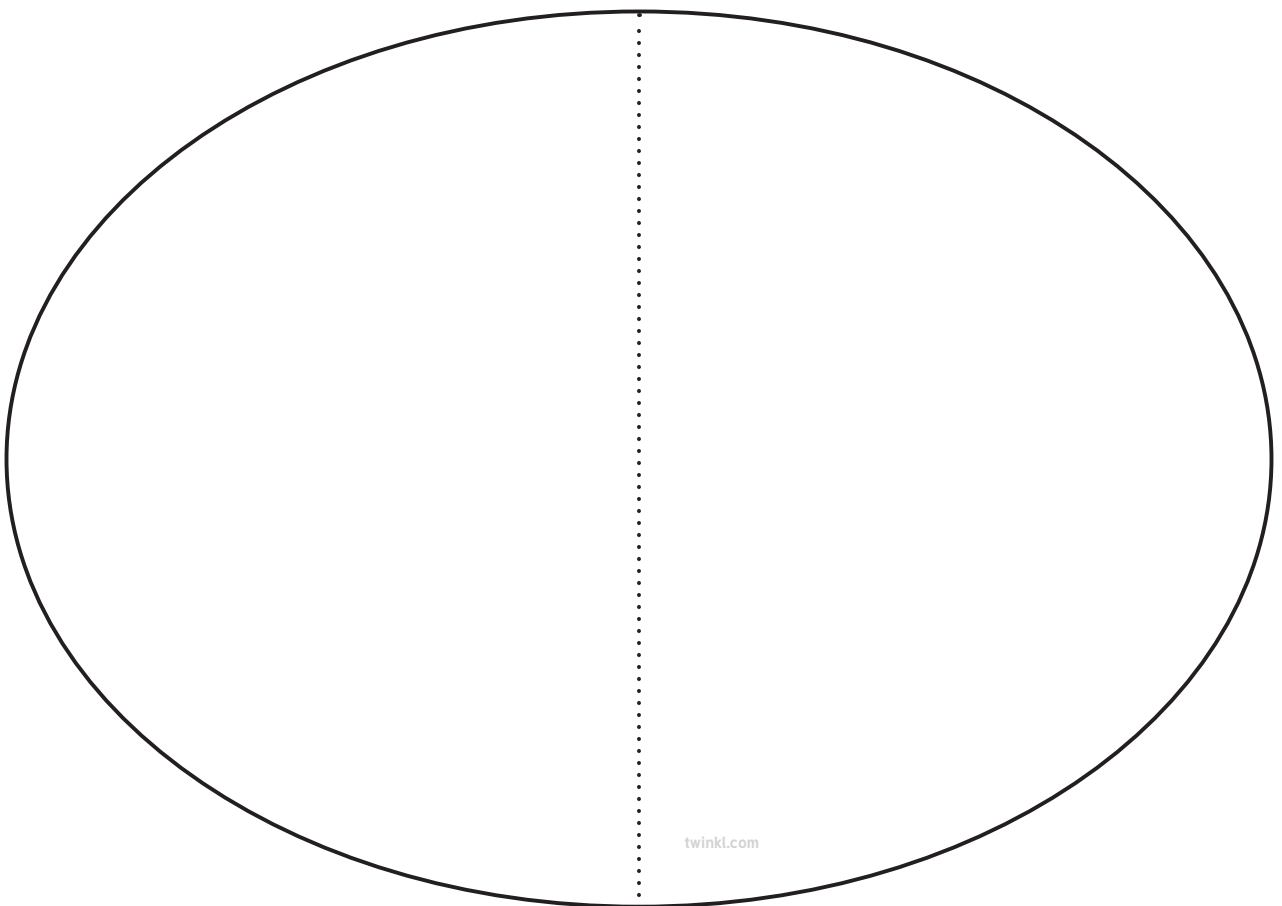

twinkl.com

A large, empty rectangular box with a thin black border, occupying the left half of the page. It is intended for drawing or writing.

A large rectangular box with a thin black border, occupying the right half of the page. It is divided into two sections. The top section is a large empty rectangle for drawing. The bottom section contains ten horizontal lines for writing.

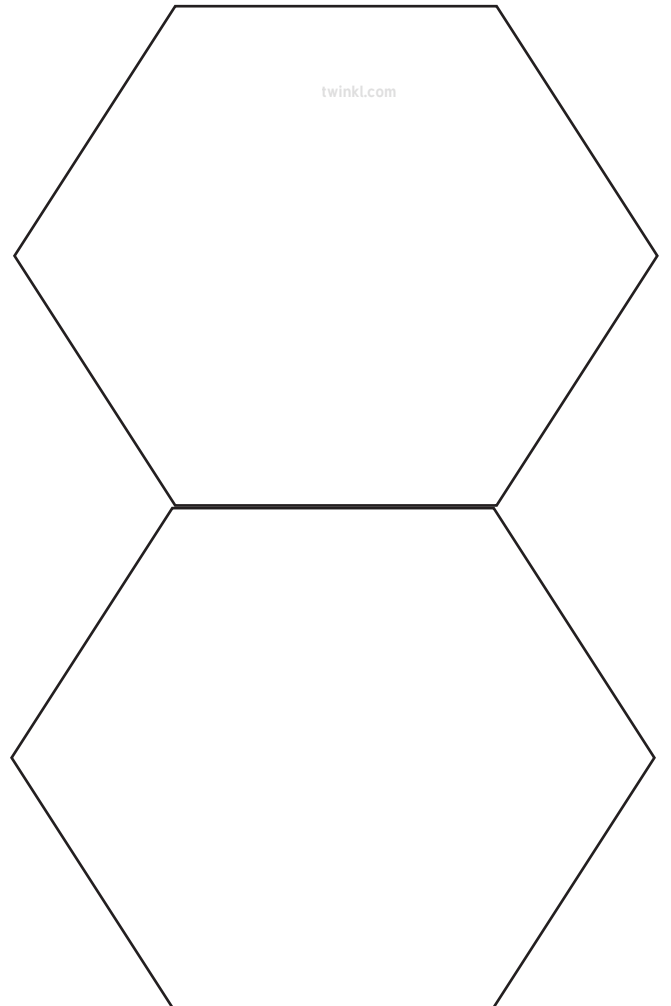
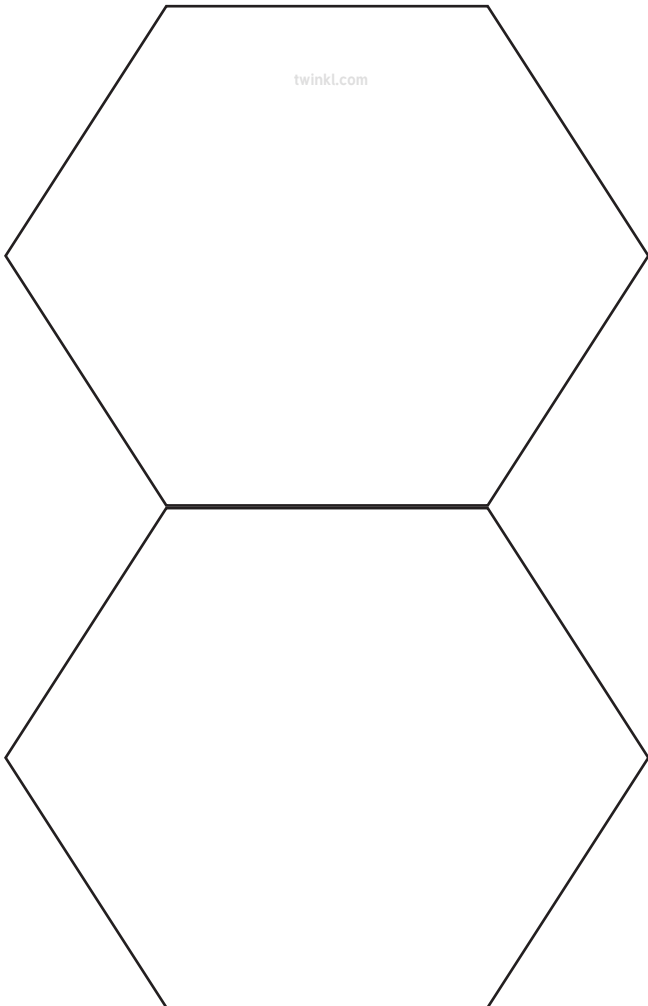
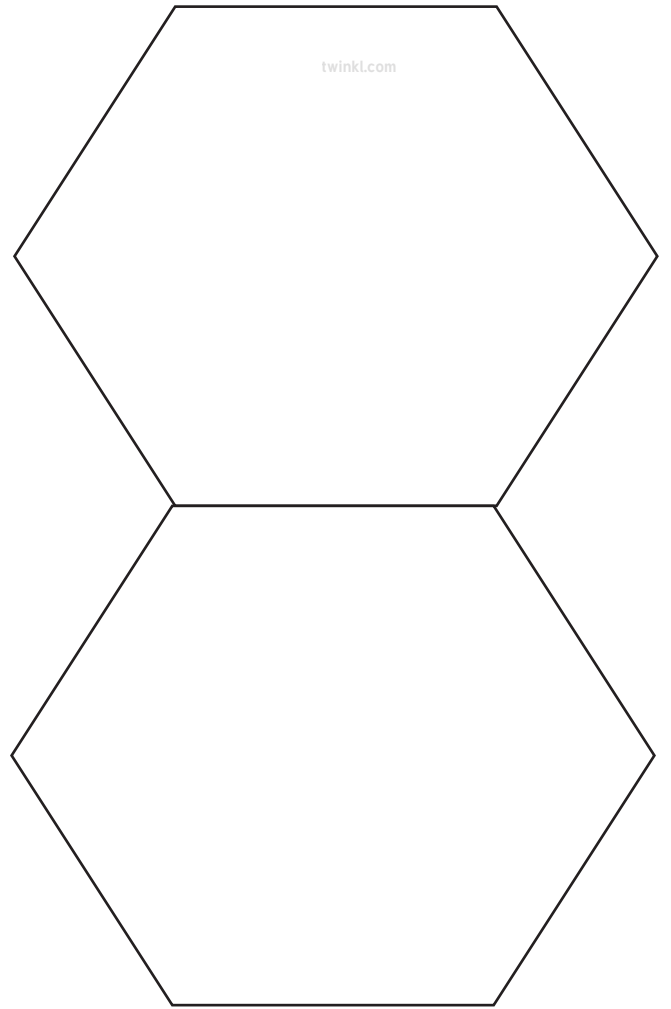
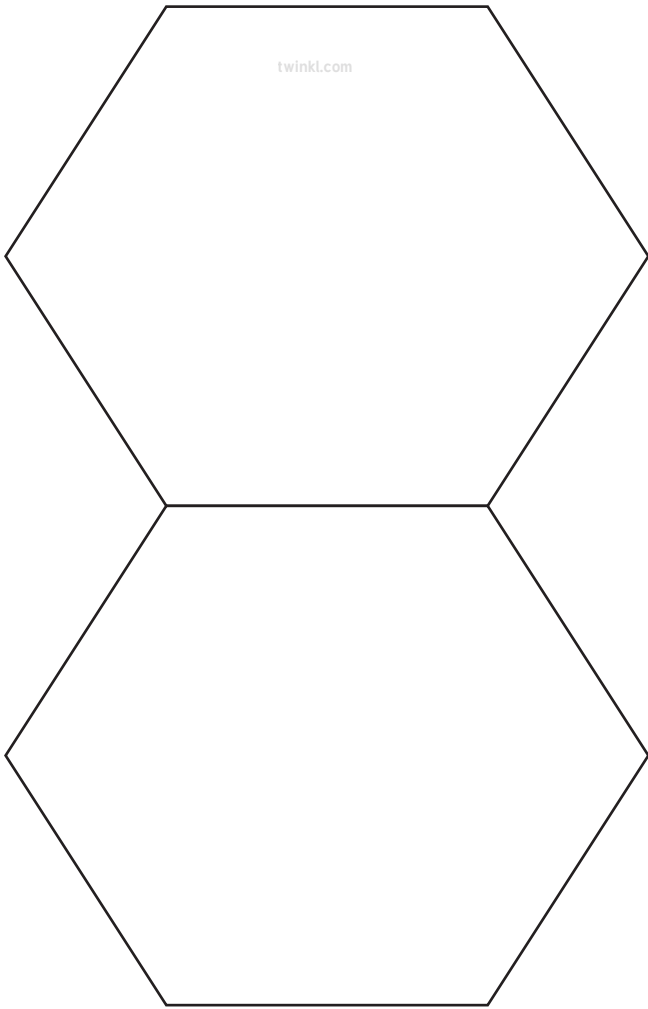

twinkl.com

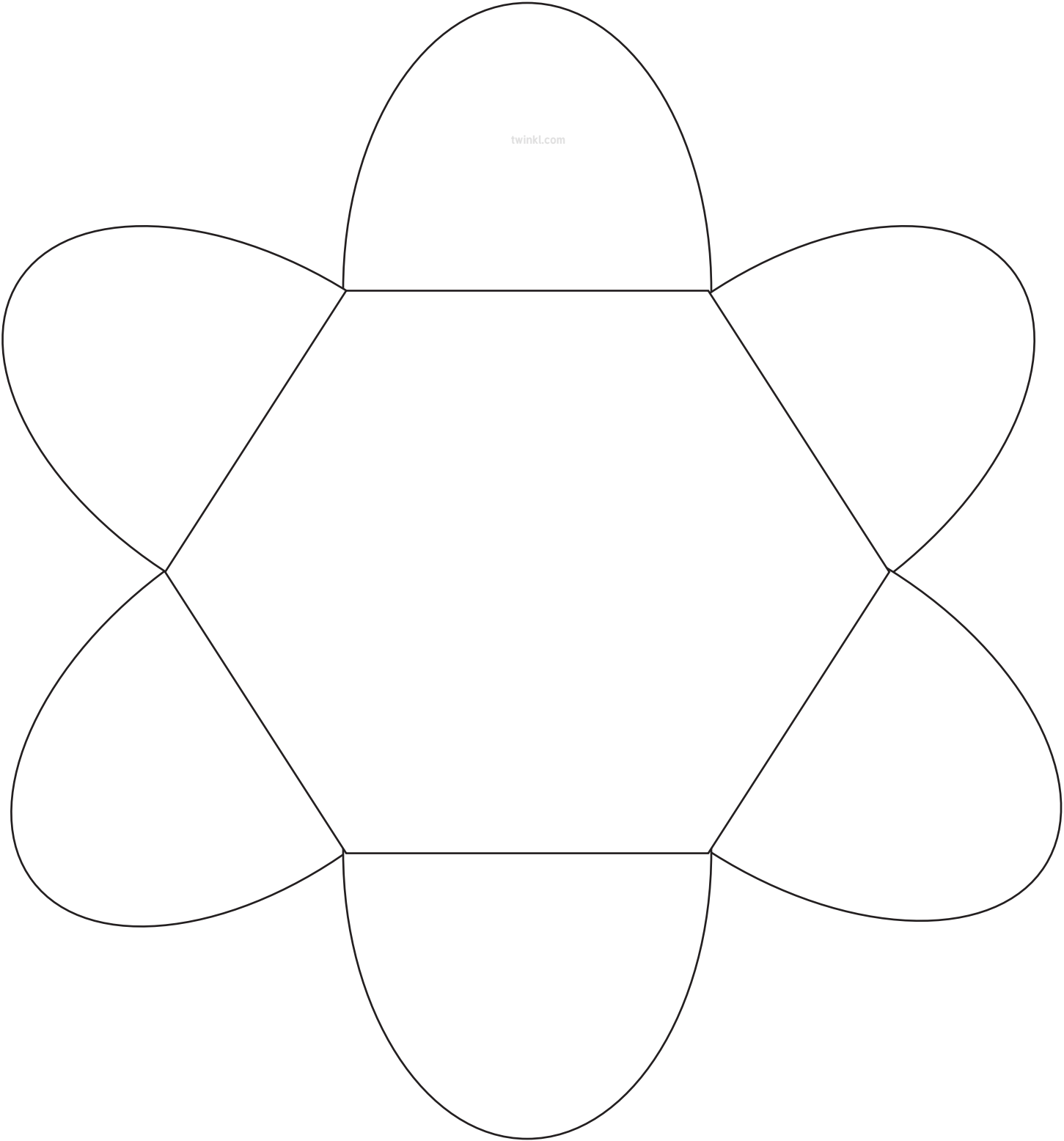

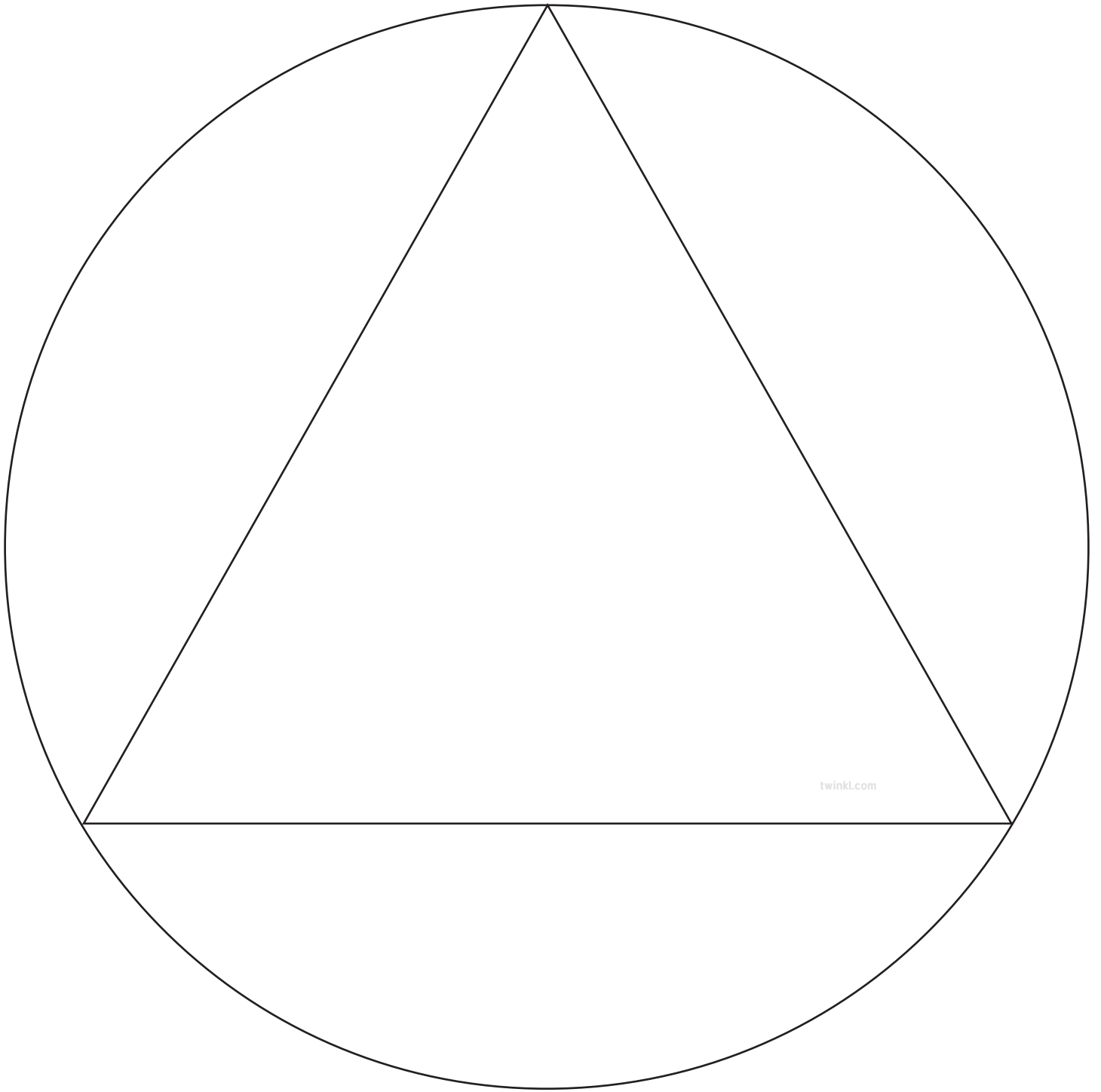

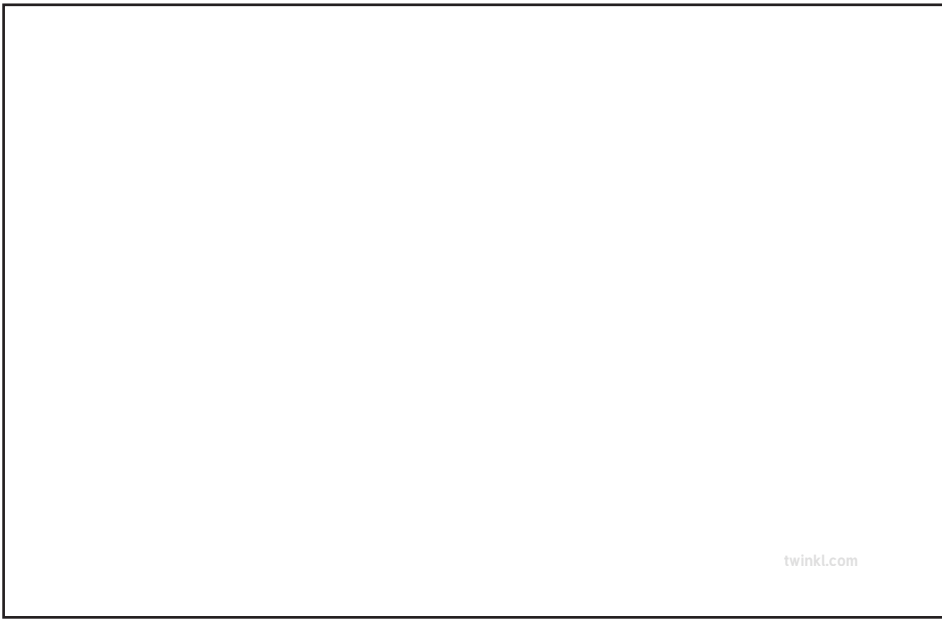

twinkl.com



twinkl.com



twinkl.com

